

## Development of Building Information Modeling (BIM)-based Real-time Fire Alert System to Reduce Fire Impact in Bangladesh

*Md. Abu Safayet*<sup>1)\*</sup>, *Mizanoor Rahman*<sup>2)</sup> and *S.M. Asif Anam*<sup>3)</sup>

<sup>1), 2), 3)</sup> Department of Building Engineering and Construction Management, Khulna University of Engineering & Technology, Khulna-9203, Bangladesh.

\* Corresponding Author. E-Mail: abusafayet@becm.kuet.ac.bd

### ABSTRACT

In recent days, architectural circumstances are continuously changing as high-rise buildings, complex and confined spaces are frequently constructed in Bangladesh. Fire calamities are getting more diverse and difficult to predict. In Bangladesh's present practice, unless anyone makes a phone call to the fire station, it does not get information about the outbreak of fire. At the same time, people are rushing out of the building and experiencing accidents, because they don't know where the fire is. That's why the damage is increasingly high day by day. The purpose of this research is to build an automated real-time fire alert system using BIM to solve this issue in the context of Bangladesh. The BIM-based fire alert system is applied to a prototype building project to verify the proposed methodology and demonstrate its effectiveness in the fire alert system. The results of this study demonstrate the feasibility of integrating a fire alert system into BIM as an effective and practical method for detecting fire and sending notifications to the intended recipient (owner, control room or fire station). Furthermore, people can see the actual location of the fire in the building plan by using an Android cell phone or display monitor from anywhere through the server. The findings of this study will help save people's precious lives and mitigate heavy damage due to fire incidents.

**KEYWORDS:** Building information modeling (BIM), Automated fire alert technology, Fire notification system, Bangladesh.

### INTRODUCTION

In recent years, the economy of Bangladesh has grown rapidly, where the expansion of construction technology and developed populations led to intensive and highly land use of urban spaces. That's why day by day, gradually many complex and high-rise buildings have been constructed, such as shopping malls, residential buildings, commercial buildings, public buildings, ... etc. In addition, complex routes of fire disasters are difficult to deal with (Cheng et al., 2017). The occurrence of fire is one phenomenon that currently causes tremendous economic damages and tragedies of human death or injury in a frequent manner. From 2004

to 2018, a total of 208681 fire incidents took place all over the country, in which 5974 people lost their lives and 11506 were injured; whereas, casualties including 130 deaths and 677 injuries took place in 19642 fire incidents in 2018 (Defence, 2018). The total economic losses were estimated at 3584.12 corer taka in the same year (Defence, 2018). Furthermore, exposing reinforced concrete buildings to fire is one of the most dangerous challenges, resulting in significant damage and structural collapse, as well as loss of lives (Takla & Tarsha, 2020).

Late notification delivered to the fire department of the incident is one of the key factors of this huge loss (Al Imran & Habib, 2015). During a fire hazard, it is quite impossible to collect the emergency numbers of fire stations or to search for them in the diary. In recent

---

Received on 4/3/2021.

Accepted for Publication on 30/5/2021.

years, the government of Bangladesh has launched a national emergency helpline number 999 for immediate needs. But even then, the news does not reach the fire service at the right time, because if someone calls the emergency number, the message is delivered to the fire service in that area. That's why the fire department can not act quickly due to delays in receiving the news of the outbreak of fire (Al Imran & Habib, 2015). One more reason is that people in the building are not able to understand where the fire breaks out and how the fire has spread; so, people rush to go out of the building and make accidents (BBC, 2019). It is seen that fire damaged properties and took several lives before firefighters reached the exact place of the fire (Al Imran & Habib, 2015). To ensure personal safety, occupants use only escape opportunities or fire extinguishers to protect themselves. Although there are fire extinguishers on almost every floor, the usage of the extinguishers is not familiar to most of occupants of the building.

One of the critical factors to extinguish the fire is 'timing'. The fire gets stronger as time goes on and becomes harder for firefighters to extinguish (Department). The communication between the firefighting team and the station is inefficient (Al Imran & Habib, 2015). That's why mismanagement is created by inadequate communication between the fire stations, eventually increasing losses. The best time to escape is between the beginning of the fire and the flashover. The earlier the fire is detected, the more time occupants have to escape. As a result, the conditions of the fire scene and real-time information are critical to an emergency evacuation. The goal of this study is to develop a better fire detection system with higher accuracy and reliability and faster detection during the early stages of a fire. This study also proposes the application of BIM to construct buildings in 3D models, with the integration of a fire alert system. When the sensors detect the information of smoke and high temperature earlier, the system can send an automated SMS to the intended recipient, such as the owner, fire service and building control room. Furthermore, the system can instantly show on which floor the fire disaster is occurring in a 3D model. The proposed integration framework would help improve the efficiency and safety of evacuation and rescue operations.

## BACKGROUND

Fire monitoring is currently the basis of fire emergency management and the development of smart sensor network monitoring systems that have become crucial contents (Maksimović et al., 2015; Sarwar et al., 2018). BIM, RFID and IoT are all modern ways of fire rescue and evacuation that greatly increase the rate of survival (X.-S. Chen et al., 2018; N. Li et al., 2014; Xu et al., 2014). Wang et al. (2015) suggested an integrating structure based on BIM, consisting of four modules: evacuation evaluation, emergency exit planning, safety training and maintenance of equipment. In combination with FDS simulation, the proposed system could analyze fire safety and store information that supports property management in a web environment. Cheng et al. (2017) carried out an integrated system that could be used with BIM and a wireless sensor network as an online building fire monitoring system. The system displays on a screen the fire ignition point and occupant location information to efficiently dispatch firefighters to fire rescue in a large building. Lotif et al. (2021) investigated a BIM-based method for assessing evacuation risk in high-rise buildings after a post-earthquake fire (PEF). This study demonstrated that fire and smoke simulations, as well as 3D modeling of the building, show that the building cannot meet a guaranteed evacuation plan; thus, additional appropriate equipment is needed. Based on the rationale of situational awareness, Chen et al. (2021) suggested an innovative technology-integrated framework for prototyping a proof-of-concept BIM, IoT and AR/VR system.

In previous studies, the fire notification systems focused on different stages of fire. But most of the systems can only detect fire and give ringing sounds. Although such studies attempted to build a system with functions, such as the acquisition of data in real time, tracking of occupants and management of devices and equipment, key information, such as firefighting facilities, displaying fire propagation information, information of the outbreak of fire remains incompletely reflected. The integration system of fire and disaster prevention and application development has not only become an immediate requirement for disaster prevention, but also enhances the trend towards disaster prevention (Cheng et al., 2016). In addition, disasters are

diversifying and becoming difficult to predict as the building environment continually changes. Highly focused attention has been given to fire disaster management for buildings. The tasks include alarm notification (Matthews et al., 2012; Töreyn et al., 2006; Yuan, 2011), design of the building fire evacuation instructions (Cao et al., 2016; Ran et al., 2014) and simulation of evacuation routes (Adjiski et al., 2015; Cai et al., 2016; Tanachawengsakul et al., 2016). In 2D views, the typical escape paths were normally directed, but they are unable to display the exact position of the building and the spread of fire. Many Building Information Modeling (BIM) technologies have recently been discussed for development in disaster prevention management (Choi et al., 2014; K.-C. Wang et al., 2014; S.-H. Wang et al., 2015; Zou et al., 2017). BIM can help show 3D visualization and immediately show the fire location and spreading of fire. BIM is a modern concept that can improve conventional 2D plans for the management of disaster prevention. While BIM's most significant influences are seen in the design and construction process and in subsequent phases, owners in recent years have started seeing potential benefits (Becerik-Gerber et al., 2011). BIM is also known as the process of interoperable and reusable generation, storage, management, exchange and share of building information (Vanlande et al., 2008). In addition, BIM spatial information may also help create hidden relations between evacuation routing positions and environmental risks and thus reduce uncertainty in the emergency decision-making process (Zhichong & Yaowu, 2009). For example, the closest hydrants, electrical systems, harmful matter and floor plans of the building can be identified on an emergency route during a fire in a commercial building. On the other hand, the prevention of fire disasters must include sensing technology. Therefore, the main aspects of the study are - (i) "Effective Detection" to ensure earlier detection and accurate alarm capabilities, (ii) "Generate Call/SMS" to generate automated Call/SMS and send it to the intended recipient, such as fire service, owner and control room of the building. (iii) "Show Location" to show the exact location and to show the spread of fire on the display monitor and (iv) "Accessibility" by authorized login, where anyone can see the situation of fire in building from anywhere. This study proposes the use of BIM for buildings with integrated fire sensors in

3D model massing. When the sensor will detect the smoke/heat, the system can send the Call/SMS to the intended recipient (fire service, owner or control room) and sound alarm and at the same time, the display monitor will show the exact real-time fire location with the help of BIM model. An authorized person can connect the server and show the real-time fire spreading anywhere.

### **BIM Technology**

Building Information Modeling (BIM) is a technical framework that explores the ability to plan, analyze, monitor and exchange all data over the project's entire life cycle (Azhar, 2011). BIM is integrated with simulations of operation for scheduling purposes (W.-C. Wang et al., 2014), structural safety analysis (Hu & Zhang, 2011) and fire safety management (N. Li et al., 2014; Ruppel & Schatz, 2011). Currently, researchers around the world are considering potential applications of BIM. Innovative and associated procedures are demonstrated by BIM to communicate or analyze construction models which are often regarded as the next-generation approach to architecture, engineering, construction (AEC) and information management (X. Li et al., 2019). Interoperability is the first step to accelerate the implementation of BIM (GCR, 2004). Automated fire alert systems with BIM act as a driver for continuous and safe interoperability. Building Information Modeling (BIM) was a significant improvement compared to the traditional Computer-aided Design Drafting (CAD) approach (C. Eastman et al., 2009). The BIM platform will also provide data storage of fire agencies to update, investigate and exchange data and use 3D visualization for the management of fire protection.

## **FRAMEWORK AND METHODOLOGY**

### **Framework of the Automated Fire Alert System**

Based on the background discussed in the last section, this study proposes and implements a BIM-based automated fire alert system. The study was executed according to Figure 1. The proposed framework contains 3D visualization capabilities based on BIM. A BIM model is the main source for information, integration and visualization. In addition, Autodesk Revit is used for completing this study which

consists of four modules: (i) Fire Sensing Module, (ii) SMS/Calling Module, (iii) Display Module and (iv) Server Module.

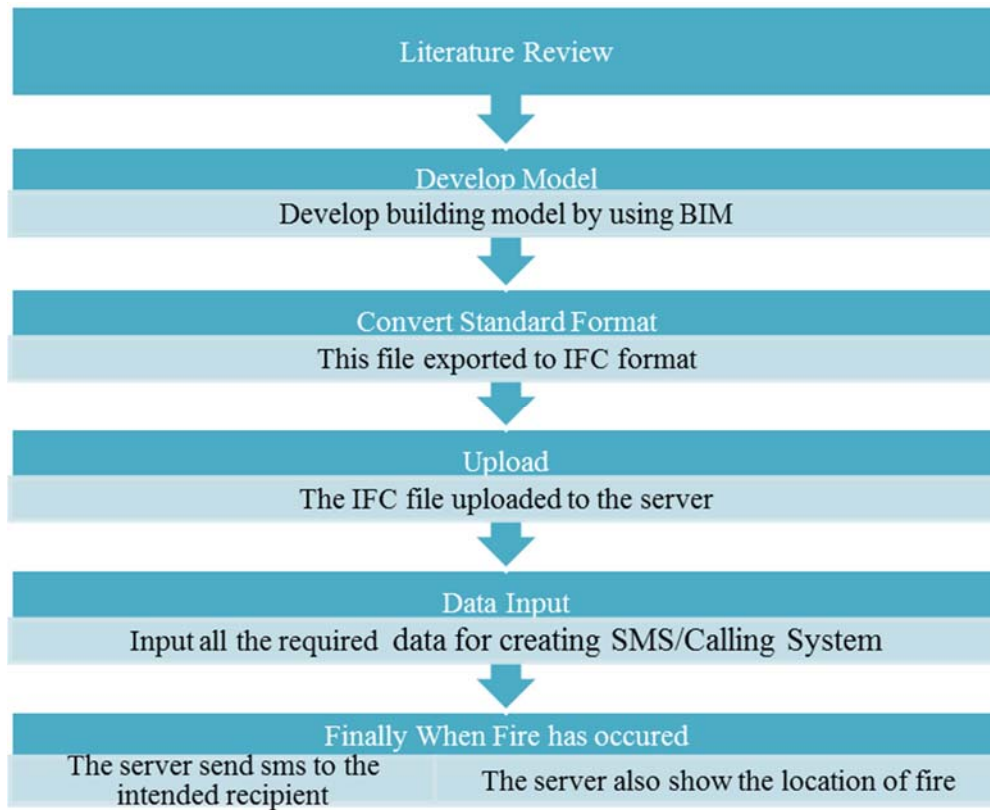

**Figure (1): Framework of the BIM-based automated fire alert system**

### Fire Sensing Module

At present, traditional fire prevention measures are fire alarm, smoke detector watching the fire, video detection and so on. But, when no one is in the building or if there is a fire at night, nobody can easily see it; so, the fire service team cannot be reached quickly. The fire sensing module mainly provides monitoring of the fire in a building. This module combines a multi-functional fire sensor with a temperature sensor, a fume sensor and a power control system. The sensor senses the fire in the stories of a building when temperature and fume exceed the alert values and notifies the right fireplace. Power management systems supply power when electricity has gone out.

### SMS/Calling Module

The SMS/Calling module can create an automated SMS/Call with the help of BIM. When fire breaks out in a particular room, then the sensor which is installed in the room will sense the fire and send a signal to the server. In this step, the mobile number/numbers which

has/have been given input will receive the required SMS/Call. The signals are also connected to the IFC (Industry Foundation Classes) file. All the required data shall be given as input to the IFC file before. So, this signal will find out the required room where the sensor is located. As a result, it can be seen in the plan where fire has been generated. Here, the fire resistance wire and small-battery backup system have been used in all sensors and display monitor.

### Web Server Module

Web server module is used to check the status of the building's real-time fire from anywhere at any time. In order to make automation, at first, the desired building is incorporated with BIM and the full building plan must be uploaded to the server. As a result, people will see in the plan in which room fire has actually occurred. This is possible by the digital signal taken from the fire detection sensors which are installed in the rooms. An authorized person can connect the server and show the real-time fire spreading anywhere.

### Display Module

The control room and each floor of the building will contain a display module. When fire breaks out in the building, the display module will show the fire location and the real-time spreading of fire. The display module shows the locations in 3D and 2D visualization. Anyone can also view it using any mobile or computer through the Authorized Login.

### Model

The model is usually depicted by 2D drawings. Using the BIM platform, it is needed to develop the conventional 2D perspective of fire alert system design projects. As the BIM model is not only a 3D model, this model also contains geometric information, manufacturing information, supplier information, costs and links with different information. The fire scene information in the BIM model, for instance, will help firefighters make decisions on the relative relationship of locations between the ignition point, field staff, evacuation routes and fire facilities, thereby reducing confusion and disaster response time. In addition, 3D IFC is required to build such fire alert systems.

### Workflow of the Proposed System

This study started with a rigorous literature review about building fire alert systems. Various types of building fire alert systems were studied. Also, more was studied about the loss of the country due to fire accidents, in accordance with the three operating phases of early detection, creating and sending SMS and displaying system. The process is divided and implemented depending on the system and users. Figure 2 shows the operating mechanism of the proposed BIM-based automated fire alert system.

A multi-storied residential building was built as a prototype building model. The 3D model of the building was created by Autodesk Revit 2017. A BIM model with a level of detail (LOD) of 300 is required for the implementation of this method. The LOD 300 BIM model should contain structural, nonstructural and architectural details (C.M. Eastman et al., 2011; Weygant, 2011). Once the 3D model was created, it was necessary to export the IFC file. IFC is a standard for open BIM data exchange. Then, the IFC file is converted into glTF (GL Transmission Format) by the following process. The Ubuntu virtual private server moves in two

parts; one is the back-end and the other is the front-end. The back-end runs the server side script/code and the front-end runs visually. When the IFC file is uploaded to the server (*via* front-end to back-end), the file is stored in the virtual disk and after that, the IFC file is converted into DAE (Digital Asset Exchange) file format with an open-source tool called ifcConvert (Shell, 2020) through web serve PHP (Personal Home Page) with system function. The system function runs in the background. As converting the DAE file is done, the second converting process is carried out with system function. The system function converts the DAE file into glTF with the help of another open-source tool COLLADA2GLTF (Github, 2020) and finally, the file is converted into the glTF file. Now, the Ubuntu virtual private server processes the data of the glTF file for finding the exact room location and its 3D coordinates to perform an alert function. The room location finder function is trained to detect the floor number and room number from the IFC file. The working circuit diagram is shown in Figure 3.

First, the fire sensor detects the fire with a photo sensor. The photo sensor measures the light intensity. When the photo sensor reaches its threshold value, the signal is sent to Arduino UNO. Arduino UNO converts the analog signal into a digital signal. With the help of ESP8266 Arduino, a connection with the VPS (Virtual Private Server) is established *via* Wi-Fi.

### CASE STUDY

In order to perform this study, a prototype building was developed. The demo building was a single-unit three-storey residential building. Figure 4 shows the prototype building model. The 3D model of the building was then built using Autodesk Revit 2017 and the model was created to the point of detail. Figure 5 indicates the Revit model.

In this study, 6 sensors are embedded as nodes on the second floor of the prototype building (e.g. master bedroom, master bedroom toilet, living area, stair area, library, library toilet), with a distance of 5m between nodes. Fig. 6 represents the sensor location of the building. Each sensor ID is fixed for each room. There is a number of ports in this Arduino board and each port is fixed for each room. The room number of the BIM model and the ID that was installed in each room must be the same. Table 1 represents the relationship between

the sensor ID and space number.

It was essential to transfer the model to the server after creating the 3D model. The model was converted into an IFC file. The IFC file is then converted into glTF (GL Transmission Format) to transfer the Revit model to the server. This is not a fact whether or not the model

was created using Revit, ArchiCAD or Tekla; however, the actual fact is that the model should be converted into IFC file as the result of this server only permits IFC files. Figure 7 shows the actual scenario of the model after transferring *via* IFC.

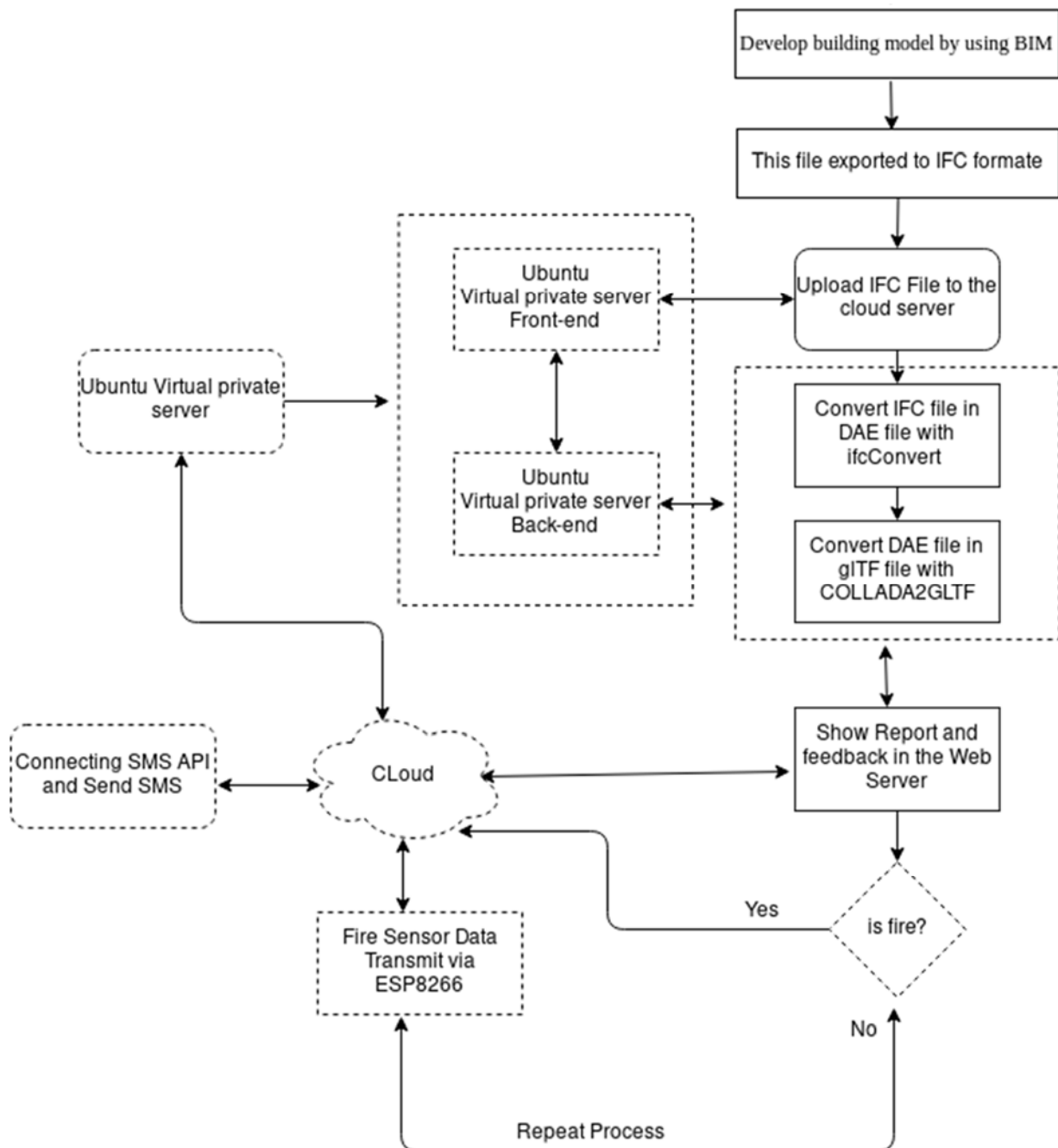

Figure (2): Workflow of the BIM-based automated fire alert system

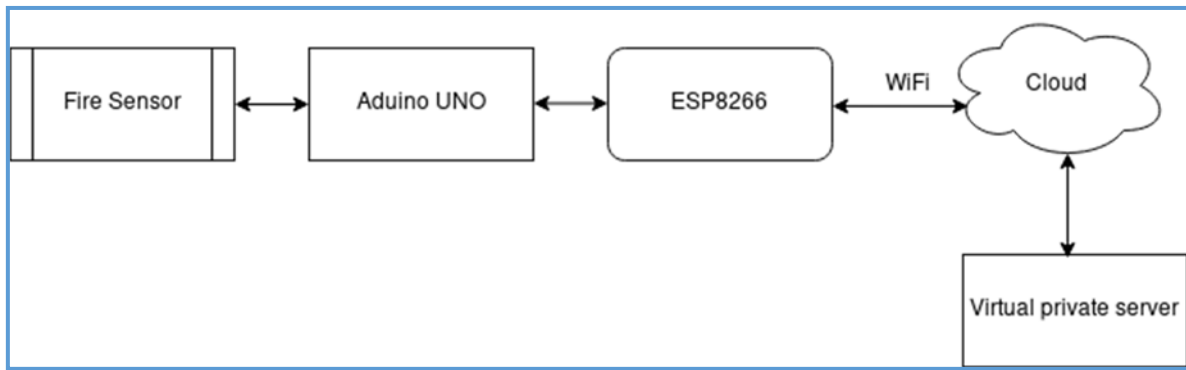

Figure (3): Working circuit diagram



Figure (4): Actual image of prototype building

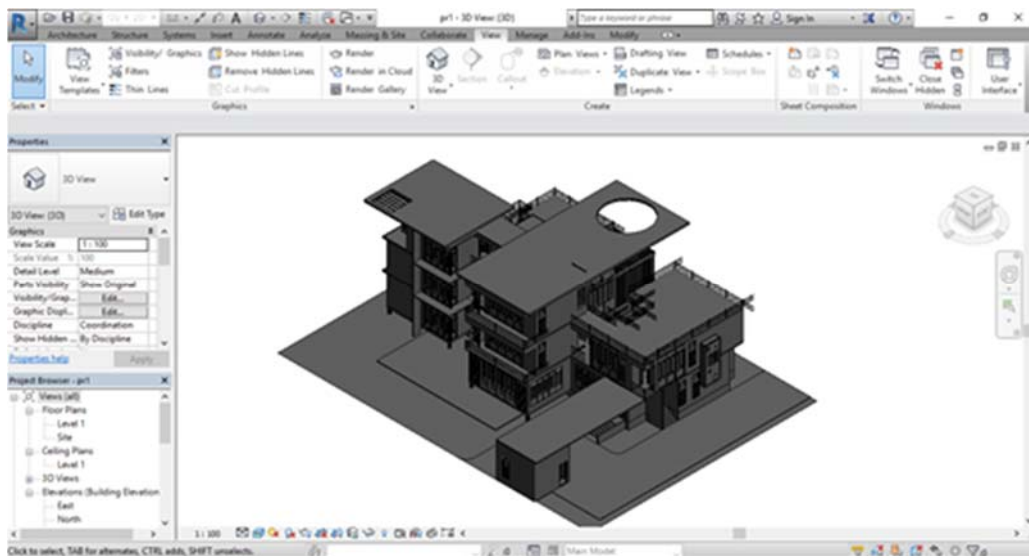

Figure (5): BIM model (Autodesk Revit)

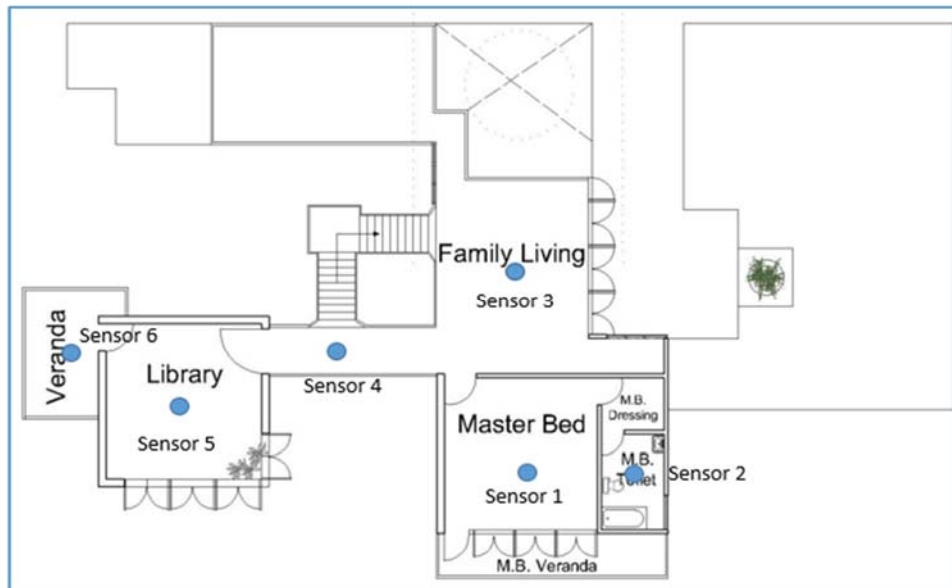

Figure (6): Sensor location of the building (2<sup>nd</sup> floor)

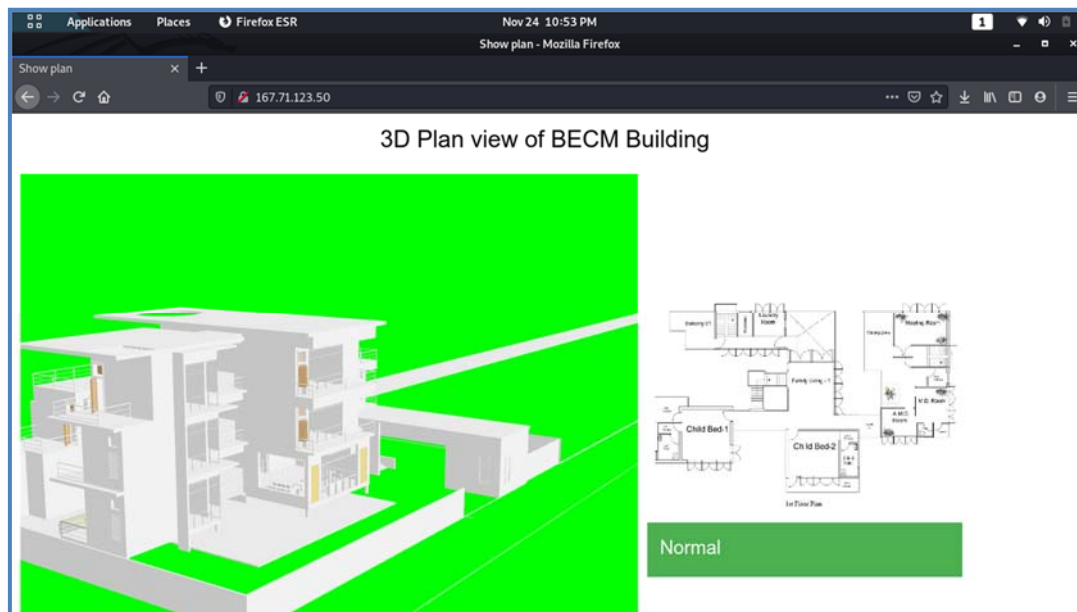

Figure (7): Transferring building model (server)

Table 1. ID for sensor on the 2<sup>nd</sup> floor of the building

Categories	Floor No.	Space No.	Sensor ID
Master Bed (MB)	02	307	01
MB Toilet	02	308	02
Family Living	02	309	03
Stair Area	02	310	04
Library	02	311	05
Library Toilet	02	312	06

After completing uploading the building model, the most important step was to input some information (sensor number, room number, building name, building

location, floor number and mobile number) needed to create SMS/Call. The room number of the BIM model and the sensor number that was installed in each room



must be the same. All the required data is input to the server to create SMS/Call service. The interface of the input interface is shown in Figure 8 (a, b, c and d). By this time, all the required data has been input and added to the data interface successfully. All the data which has been input can be seen now. So further, the data which has been given as input can be verified. If there is any wrong data, it can be easily removed and consequently, the corrected data can be input. By clicking on ‘view all data interface’, the interface looks likes Figure 9.

For this study, the fire was set on the second floor, room number the sensed signal 307 and the sensor installed in this room senses the fire and converts the sensed signal into an electrical signal. Then, this signal is sent to the digital output of the Arduino UNO board. And then, the Arduino communicates with ESP8266 with the help of WiFi to make a secure connection of

developed virtual server. By the meantime, this data will be processed with the help of PHP code. In this step, the mobile number/numbers which has/have been given input will receive the required SMS/Call. The name and location of the fire-affected building, the room number and the floor are mentioned in the SMS. Besides, the time of occurrence of the fire is also added in the SMS. Figure 10 shows the sample SMS format.

The data is also connected to the gITF file. All the required data shall be given as input to the gITF file before. So, this data will find out the required room where the sensor is located. As a result, it can be seen in the 2D and 3D views where fire has been generated. The actual location of the fire can be seen in the building plan by using a tab or Android cell phone. Figure 11 shows the automated location of the fire in the building (2D and 3D Views).

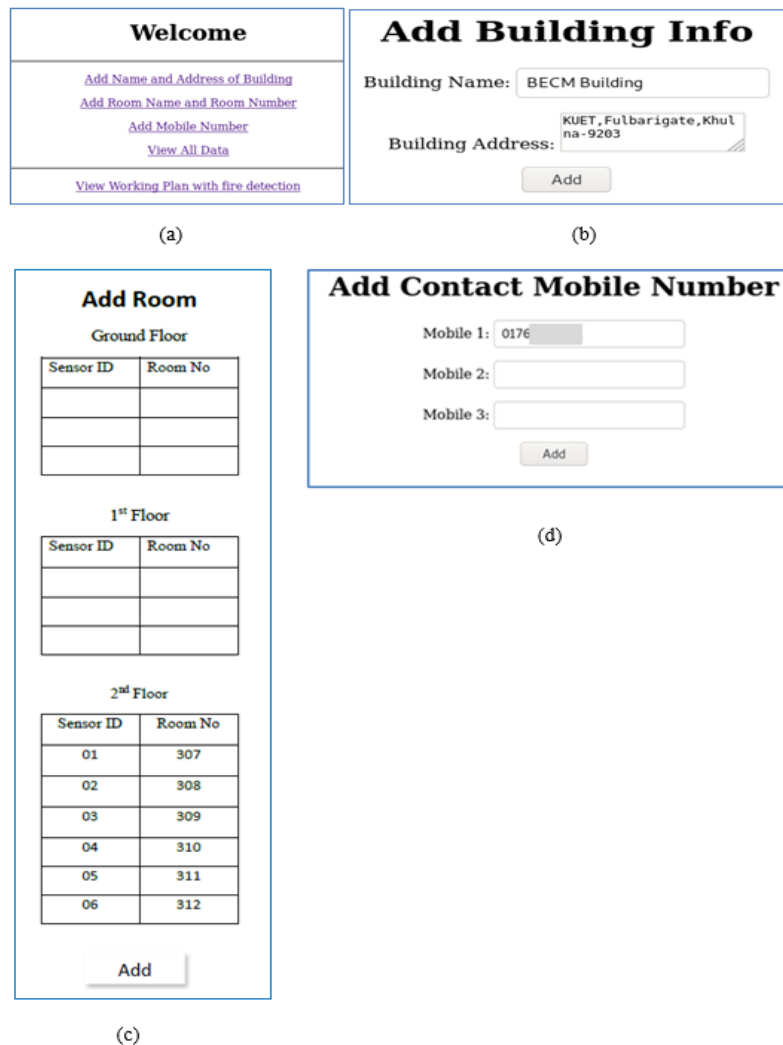

Figure (8): (a, b, c, d): Input interface

## View All Data

---

**Building Name: BECM Building**  
**Building Address: KUET, Fulbarigate, Khulna-9203**

**Ground Floor**

**1<sup>st</sup> Floor**

**2<sup>nd</sup> Floor**

01	307
02	308
03	309
04	310
05	311
06	312

**Mobile Number**

1. 017

Figure (9): Viewing data interface



Figure (10): Automated SMS format



Figure (11): Automated location of fire in the building (2D and 3D views)

## RESULTS & SYSTEM BENEFITS

The overall scenario deals with the quickest method of delivering the fire notification to the intended authority, such as the owner, fire station and control room and show the actual location of the fire that can be seen on the display monitor installed on each floor. The automated fire alert system was successfully implemented on a prototype building model for fire alert and showed the actual location and spreading of fire. The performed research illustrates that no one makes a call to the fire stations. This automated system generates SMS/Call when the fire breaks out. People will see in the plan and 3D view in which room fire has actually occurred with the help of BIM model and can easily get out of the building the other way. Thus, the use of BIM in the building sector plays a vital role and if it is used in Bangladesh, the building sectors would benefit a lot.

## CONCLUSIONS

Currently, fireproofing is used in the construction of many buildings. When a fire breaks out, people who live in these buildings face significant injuries and property

losses. Thousands of people get injured and burnt and consequently, they have to embrace premature death because of not giving attention to the fire management system. The location of the fire in real time, the spreading of smoke and the location of the occupants must all be taken into account during the fire response stage. Furthermore, saving lives in building fires requires quickly and accurately identifying fires, attacking them aggressively and reaching occupants who may be trapped inside a building to provide disaster relief through firefighters. It has been found that the main cause of damage and fatalities due to fire is that the fire station does not get the news of the occurrence of fire in time. Though all the fire stations have to follow the hard and fast rule of getting out from the station with their fire ambulance within maximum 5 seconds of getting the news of fire occurrence, the fire cannot be brought under control, only because the fire station does not get the news of the fire in time. So, to minimize losses due to fire, the main concern is to convey the news of the occurrence of fire to the fire station as early as possible.

In order to achieve automation, people will see in the plan in which room fire has actually occurred. Another

feature of this research is that, as soon as the sensors installed in the rooms sense the fire, they will send a mobile SMS/Call to the intended recipient (owner, building control room, nearest fire station). In the mobile SMS/Call, the name and location of the building as well as the floor and room number and the time of occurrence of fire are added, due to which it will become easier for the fire rescue team to find out the room (or rooms) on fire. Besides, the fire rescue team can also get

a building plan from the control room and can see in the plan where fire has actually taken place.

Now, if a comparison is made between the present scenario and the proposed automated system, there is no need for personnel to make a phone call to the fire station during the fire. Rather, an automated SMS/Call will be sent to the fire station, due to which firefighters can rush to the spot as early as possible and the damages and fatalities due to fire can be reduced in this process.

## REFERENCES

- Adjiski, V., Mirakovski, D., Despodov, Z., and Mijalkovski, S. (2015). "Simulation and optimization of evacuation routes in case of fire in underground mines". *Journal of Sustainable Mining*, 14 (3), 133-143.
- Al Imran, M.A., and Habib, M.A. (2015). "Effective fire event notification system for fire service department of Bangladesh". Paper Presented at the 2015 International Conference on Electrical Engineering and Information Communication Technology (ICEEICT).
- Azhar, S. (2011). "Building information modeling (BIM): Trends, benefits, risks and challenges for the AEC industry". *Leadership and Management in Engineering*, 11 (3), 241-252.
- BBC. (2019). "From: <https://www.bbc.com/news/world-asia-47751005>
- Becerik-Gerber, B., Jazizadeh, F., Li, N., and Calis, G. (2011). "Application areas and data requirements for BIM-enabled facilities management". *Journal of Construction Engineering and Management*, 138 (3), 431-442.
- Cai, Y., Lin, Z.-Y., Mao, J., Bai, G., and Hu, J.-W. (2016). "Study on law of personnel evacuation in deep buried metro station based on the characteristics of fire smoke spreading". *Procedia-Engineering*, 135, 544-550.
- Cao, S., Song, W., and Lv, W. (2016). "Modeling pedestrian evacuation with guiders based on a multi-grid model". *Physics Letters A*, 380 (4), 540-547.
- Chen, H., Hou, L., Zhang, G. K., and Moon, S. (2021). "Development of BIM, IoT and AR/VR technologies for fire safety and upskilling". *Automation in Construction*, 125, 103631.
- Chen, X.-S., Liu, C.-C., and Wu, I.-C. (2018). "A BIM-based visualization and warning system for fire rescue". *Advanced Engineering Informatics*, 37, 42-53.
- Cheng, M.-Y., Chiu, K.-C., Hsieh, Y.-M., Yang, I.-T., and Chou, J.-S. (2016). "Development of BIM-based real-time evacuation and rescue system for complex buildings". Paper Presented at the ISARC: Proceedings of the International Symposium on Automation and Robotics in Construction.
- Cheng, M.-Y., Chiu, K.-C., Hsieh, Y.-M., Yang, I.-T., Chou, J.-S., and Wu, Y.-W. (2017). "BIM-integrated smart monitoring technique for building fire prevention and disaster relief". *Automation in Construction*, 84, 14-30.
- Choi, J., Choi, J., and Kim, I. (2014). "Development of BIM-based evacuation regulation checking system for high-rise and complex buildings". *Automation in Construction*, 46, 38-49.
- Defence, B.F.S.A.C. (2018). "statistics of fire incident in Bangladesh". Retrieved on 03/11/ 2019, from: <http://www.fireservice.gov.bd/site/page/18e08e09-ad74-4aa6-9494-84d1fdc18ad3/%E0%A6%85%E0%A6%97%E0%A7%8D%E0%A6%A8%E0%A6%BF%E0%A6%A6%E0%A7%81%E0%A6%B0%E0%A7%8D%E0%A6%98%E0%A6%9F%E0%A6%A8%E0%A6%BE>
- Department, C.F. "The nature of fire". [Online]. Available at: <http://www.charleston-sc.gov/index.aspx?NTD=719>
- Eastman, C., Lee, J.-M., Jeong, Y.-S., and Lee, J.-K. (2009). "Automatic rule-based checking of building designs". *Automation in Construction*, 18 (8), 1011-1033.

- Eastman, C.M., Eastman, C., Teicholz, P., Sacks, R., and Liston, K. (2011). "BIM handbook: A guide to building information modeling for owners, managers, designers, engineers and contractors". John Wiley and Sons.
- GCR, N. (2004). "Cost analysis of inadequate interoperability in the US capital facilities industry". National Institute of Standards and Technology (NIST), 223-253.
- Github. (2020). From: <https://github.com/KhronosGroup/COLLADA2GLTF>
- Hu, Z., and Zhang, J. (2011). "BIM-and 4D-based integrated solution of analysis and management for conflicts and structural safety problems during construction: 2. Development and site trials". *Automation in Construction*, 20 (2), 167-180.
- Li, N., Becerik-Gerber, B., Krishnamachari, B., and Soibelman, L. (2014). "A BIM-centered indoor localization algorithm to support building fire emergency response operations". *Automation in Construction*, 42, 78-89.
- Li, X., Shen, G.Q., Wu, P., and Yue, T. (2019). "Integrating building information modeling and prefabrication housing production". *Automation in Construction*, 100, 46-60.
- Lotfi, N., Behnam, B., and Peyman, F. (2021). "A BIM-based framework for evacuation assessment of high-rise buildings under post-earthquake fires". *Journal of Building Engineering*, 102559.
- Maksimović, M., Vujović, V., Perišić, B., and Milošević, V. (2015). "Developing a fuzzy logic-based system for monitoring and early detection of residential fire based on thermistor sensors". *Computer Science and Information Systems*, 12 (1), 63-89.
- Matthews, S., Sullivan, A., Gould, J., Hurley, R., Ellis, P., and Larmour, J. (2012). "Field evaluation of two image-based wildland fire detection systems". *Fire Safety Journal*, 47, 54-61.
- Ran, H., Sun, L., and Gao, X. (2014). "Influences of intelligent evacuation guidance system on crowd evacuation in building fire". *Automation in Construction*, 41, 78-82.
- Rüppel, U., and Schatz, K. (2011). "Designing a BIM-based serious game for fire safety evacuation simulations". *Advanced Engineering Informatics*, 25 (4), 600-611.
- Sarwar, B., Bajwa, I.S., Ramzan, S., Ramzan, B., and Kausar, M. (2018). "Design and application of fuzzy logic-based fire monitoring and warning systems for smart buildings". *Symmetry*, 10 (11), 615.
- Shell, I. O. (2020). From: <http://ifcopenshell.org/>
- Takla, M., and Tarsha, I. (2020). "Effect of temperature on carrying capacity of concrete columns confined with multi-layers of CFRP". *Jordan Journal of Civil Engineering*, 14 (1).
- Tanachawengsakul, T., Mishima, N., and Fuchikami, T. (2016). "A simulation study on fire evacuation routes in primary stage for a historic canal residential area". *Procedia-Social and Behavioral Sciences*, 216, 492-502.
- Töreyn, B. U., Dedeoğlu, Y., Güdükbay, U., and Cetin, A. E. (2006). "Computer vision-based method for real-time fire and flame detection". *Pattern Recognition Letters*, 27 (1), 49-58.
- Vanlande, R., Nicolle, C., and Cruz, C. (2008). "IFC and building lifecycle management". *Automation in Construction*, 18 (1), 70-78.
- Wang, K.-C., Shih, S.-Y., Chan, W.-S., Wang, W.-C., Wang, S.-H., Gansonre, A.-A., . . . , and Yeh, M.-F. (2014). "Application of building information modeling in designing fire evacuation: A case study". Paper Presented at the ISARC: Proceedings of the International Symposium on Automation and Robotics in Construction.
- Wang, S.-H., Wang, W.-C., Wang, K.-C., and Shih, S.-Y. (2015). "Applying building information modeling to support fire safety management". *Automation in Construction*, 59, 158-167.
- Wang, W.-C., Weng, S.-W., Wang, S.-H., and Chen, C.-Y. (2014). "Integrating building information models with construction process simulations for project scheduling support". *Automation in Construction*, 37, 68-80.
- Weygant, R.S. (2011). "BIM content development: Standards, strategies and best practices". John Wiley and Sons.
- Xu, Z., Lu, X., Guan, H., Chen, C., and Ren, A. (2014). "A virtual reality-based fire training simulator with smoke hazard assessment capacity". *Advances in Engineering Software*, 68, 1-8.
- Yuan, F. (2011). "Video-based smoke detection with histogram sequence of LBP and LBPV pyramids". *Fire Safety Journal*, 46 (3), 132-139.

Zhichong, Z., and Yaowu, W. (2009). "Framework of spatial decision support system for large-scale public building evacuation". Paper Presented at the 2009 WRI Global Congress on Intelligent Systems.

Zou, Y., Kiviniemi, A., and Jones, S.W. (2017). "A review of risk management through BIM and BIM-related technologies". *Safety Science*, 97, 88-98.