

A Review and Comparative Study of Boundary Conditions Used for Wave Transmission in Soil with Application in Free Field Response

Lakshmi Kant¹⁾* and Avik Samanta²⁾

¹⁾ Assistant Professor, Department of Civil Engg., RRSD College of Engg., Begusarai, India.

* Corresponding Author. E-Mail: lakshmikantseth@gmail.com@gmail.com

²⁾ Assistant Professor, Department of Civil Engg., Indian Institute of Technology Patna, India.
E-Mail: asamanta@iitp.ac.in

ABSTRACT

In soil–structure interaction (SSI) problem, the structural response is affected by additional wave energy dissipation through radiation and material damping of soil. The infinite soil around a sizeable stiff structure behaves like a natural damper. The modeling of such phenomenon of wave transmission that radiates outward from the vibrating structures towards infinity has significant difficulties. In numerical analysis, the only finite domain of the soil medium is analyzed and boundary condition (BC) is imposed to prevent the outgoing radiation waves from reflecting of the boundary region. The accuracy of SSI simulation in numerical analysis depends on how well the non-reflecting boundary condition is working in the simulation. Many approaches have been developed to simulate such boundary conditions over the past few decades and the accuracy of wave-absorbing BC has been improved over the period of time. This paper aims to review and implement the different wave transmitting boundary conditions that are generally familiar in analyzing problems in the soil–structure interaction. Accuracy, suitability and application of wave-absorbing BCs are studied in this paper using the finite element program ABAQUS modeling.

KEYWORDS: Soil-structure interaction, Boundary condition, Finite element (FE), Free field response of soil, Numerical analysis.

INTRODUCTION

Experimental tests, such as shake table tests, are most suitable to predict the dynamic behavior of soil. Still, a flexible boundary is required (Tabatabaiefar, 2016) to take care of the reflection of a wave coming toward the boundary. Shake table tests cannot be performed for a large volume of soil. As a result, the finite element method (FEM) gained more popularity due to its simulation capacity related to the real complex problem with more efficiency and accuracy (Far, 2017). It is used by many researchers to simulate seismic ground excitation problems, such as SSI. The simulation of the infinite domain of soil in FEM is performed by taking only the finite domain of soil. Soil domain always remains finite, even as a large domain of soil is taken. The general method for solving the static problem is executed by applying the simplest fixed boundary

condition. But, in the case of ground excitation problem, it is carried out by dividing the infinite soil into two parts as the near field and far field to take care of wave transmission in the infinite domain of soil. The part which includes the geometric irregularity and non-homogeneity of the foundation is called near field, while the far field is an isotropic homogeneous elastic domain beyond the near field. The near field is modeled using finite elements and the far field is modeled by some particular artificial boundaries or connecting some special elements on the truncated boundary, which is a part of the representation of the finite elements. There are many artificial BCs that are developed and used by researchers (Lysmer and Kuhlemeyer, 1969; Jingbo and Du Yixing, 2007) to overcome some of the limitations of fixed BC. Artificial BCs can be broadly divided into two parts, which are local boundary conditions and global boundary conditions. Local boundary conditions provide a low-accuracy solution, but with high

Received on 17/6/2020.

Accepted for Publication on 28/8/2020.

efficiency. They are widely used in FEM due to their small storage requirements, low computation time and strong practicality. In local BC conditions, each degree of the freedom of the boundary is coupled with a local boundary element and local boundary conditions are generally used in time domain analysis. Global boundary conditions provide more accurate results for the wave propagation problem, but computationally, they are not efficient in comparison with local boundary conditions. In global BCs, all degrees of freedom of the boundary of the domain are coupled with the global boundary conditions and global boundary conditions are generally used in frequency domain analysis. Different BCs have been proposed and implemented since the early age of the SSI problem. Non-reflecting BCs are developed based on the boundary element method, boundary integral method, coupled finite element and boundary element method and infinite element method. Local BCs are considered as accurate as global boundary conditions in time domain analysis, as suggested by Givoli (2004). Local BC consists of a mass, dashpot and spring in combination, which is easier to use in non-linear dynamic problem simulation in FEM modeling in comparison with global BC.

This study presents a review of different BCs used for wave-absorbing boundary conditions in the dynamic wave propagation problem. A comparative study of two selected widely used local boundary conditions through three-dimensional (3D) modeling is carried out to analyze the wave amplification in soft homogeneous and layered soil. This comparative analysis is carried out using ABAQUS (Abaqus, 2013) finite element software program. The results of these local BCs are compared with the outcome of the more widely used non-linear response analysis code DEEPSOIL (Hashash et al., 2011).

WAVE-ABSORBING BOUNDARY CONDITIONS

There are three types of boundary conditions: elementary, consistent (global) and local boundary conditions. Elementary boundaries are mainly used in static analyses (i.e., zero stress or zero displacements at the boundary) and cannot simulate the radiation of wave energy toward infinite soil domain and this is more valuable where radiation of wave energy has minimal impacts, like the interface of delicate and hardened soils. Free field, fixed boundaries and tie BC are examples of

elementary boundary conditions. Peiris et al. (2014) used elementary boundary condition (free-boundary condition) successfully in the study of the soil-pile interaction of a pile embedded in a deep multi-layered soil under seismic excitation. Alfach (2012) studied the seismic performance of pile foundations using free field boundary conditions. He proposed that free boundary condition can be utilized because of its straightforwardness. Similarly, Matinmanesh and Asheghabadi (2011) used tie BC in SSI analysis of buildings placed over the sandy soil in 2D FEM due to simplicity of its application.

In the following paragraph, global and local BCs are talked about with their applications done by various researchers. They concluded that elementary BC doesn't have a lot of utilization in soil-structure interaction, as this BC does not consider the effect of radiation wave energy at the interface of soft and stiff soils.

Consistent Non-reflecting Boundary Conditions

Smith (1974) developed a non-reflecting 2D boundary condition by considering that reflection of the boundary can be eliminated by adding the solution of Dirichlet and Neumann problems. Dirichlet condition is imposed by considering a fixed boundary and the Neumann condition is imposed by considering free-field motion with the derivative of velocity as zero.

Underwood and Geers (1981) developed a boundary element (BE) treatment of far-field soil by application of a doubly asymptotic approximation (DAA). 2D plane strain response of structures surrounded by an elastic half-space of soil was studied. The authors developed the methodology for the matrix equation of motion for a structure embedded in an elastic soil. They concluded that this BE method performed well in simulating non-reflecting boundary conditions for the dynamic seismic problem.

Higdon (1986) developed absorbing BC for the multi-dimensional wave equation directly with a difference approximation to the equation, instead of finding the first analytical boundary conditions and then discretizing the analytical conditions. It was reported that this fact leads to a general and straightforward canonical form for analytical absorbing boundary conditions, which provides more accurate results for non-zero incident wave propagation.

Karpurapu (1988) discussed the development and

application of a mapped-type composite infinite element for simulating the response of half-space 2-phase media through subroutine listing in the finite element scheme. It was concluded that using infinite elements in analyzing unbounded domains containing problems yields accurate solutions at much lesser computational effort compared to the conventional finite element methods. A new integration scheme for the infinite elements was recommended that was used for the finite elements in the mesh to achieve better efficiency and accuracy in numerical simulation of the dynamic problem of the infinite domain of soil.

Medina (1992) used the infinite elements to model the soil structure problem and it was reported that using infinite elements, one can reduce the degree of freedom of the problem. It provides an efficient method to solve the seismic ground motion problem.

Yun et al. (1995) developed three axisymmetric infinite elements. These are: the horizontal, the vertical and the infinite corner elements, which were used for the elastodynamic problems of a layered soil in the time domain. An efficient new integration scheme was developed for calculating the element matrices for multi-component waves. The effectiveness of the proposed infinite elements was shown *via* example analyses for rigid disks on a homogeneous and layered infinite soil medium.

Davies and Bu (1996) developed a new boundary element solution for the response of machine foundations using infinite BE to consider the displacement of far-field behavior near the loading area. The order of the potential of the formulation was presented *via* numerical examples.

The multi-directional doubly asymptotic method was developed by Wolf and Song (1996). This method is used in the time domain based on the direct methodology for dynamic SSI problems. It was reported that it combines the advantages of the doubly asymptotic method and the multi-directional method and provides more accurate results for dynamic analysis.

Mulder (1997) performed experiments with Higdon's boundary conditions for different wave propagations and concluded that third-order conditions of Higdon's BCs provide acceptable results for the simple scalar wave equation and the acoustic equation. It was found that numerical experiments exhibit a consistent performance, although some improvement

would be useful, especially in the anisotropic elastic medium.

Givoli and Neta (2003) developed a new high-order sequence of absorbing BCs at higher orders for time-dependent wave propagation by making changes in Higdon's BC. It was reported that a new type of Higdon's non-reflecting boundary condition (NRBC) is straightforward in its implementation by demonstrating *via* numerical examples. It was concluded that calculation costs increase linearly with higher orders. Neta et al. (2008) applied successfully the NRBC using high-order Higdon non-reflecting boundary conditions to linear shallow-water models in the finite difference scheme.

Appelö (2003) considered mainly the two aspects of NRBC for wave motion in the infinite half-domain. A perfectly matched layer (PML) method was proposed for the simulation of advective acoustics as the first aspect. The second aspect concerns spurious waves, which are generated by discretization of domain procedure. It was concluded that the resulting method has boundary instabilities and the stability of the boundary can be assured by adding tangential viscosity as the boundary.

A new high-order local non-reflecting boundary condition (NRBC) was developed by Villamizar et al. (2017) for the propagation of time-dependent harmonic acoustic waves. An artificial boundary was introduced enclosing scatterer; the unbounded domain is discretized into a bounded computational domain and an unbounded exterior domain. The boundary condition at the artificial boundary was defined from truncated versions of the well-known Wilcox and Karp far-field expansion representations of the exact solution in the outer region. It was concluded that new absorbing BC could be used without having to enlarge the radius of the artificial boundary in 2D and 3D dynamic problems with improved accuracy and simplicity compared to other non-reflecting BCs.

Yun et al. (2007) presented a dynamic infinite element formulation that was developed for SSI both in time and frequency domains. Axisymmetric, two-dimensional and three-dimensional stratified semi-infinite soils were considered in the formulation. An approximate function of analytical solutions was used in displacement shape functions of the infinite elements in the frequency domain to simulate the properties of

multiple waves traveling into the unbounded outer far-field domain of the soil. It was concluded that the proposed infinite elements are useful in dynamic SSI problems either in the frequency domain or in the time domain.

Kazakov (2011) studied the application of mapped elastodynamic infinite elements with union shape functions to the finite element program and listed some advantages of such a method. An extension of infinite dynamic elements for seismic analysis was also developed. The SSI simulation in the time domain was compared with the SSI simulation in the frequency domain.

Su and Wang (2013) proposed an equivalent dynamic infinite element. It considers the elastic recovery of a general infinite element and the energy absorption of the viscous boundary. Then, efficiency was compared with other boundary conditions *via* numerical examples.

Samii and Lotfi (2012) used NRBC developed by Hagstrom in the fluid-structure interaction problem of a dam. It was concluded that its performance and accuracy are comparable with the exact solution. However, below a certain frequency range, it does not provide satisfactory results, mainly when it is applied at close distances from the dam.

Zhao et al. (2012) implemented a high-order accurate artificial absorbing boundary condition in time domain to simulate the SSI problem in the direct method. A seismic wave input method was presented. In this boundary condition, 1D free-field displacements at artificial boundary nodes were calculated using the finite element method. The equivalent forces on artificial boundary nodes were then obtained by resisting both the near-field finite element model and the artificial boundary condition to satisfy the nodal free field displacements.

Rajagopal et al. (2012) developed an artificial boundary condition to absorb the incoming waves toward the finite boundary at different angles of incidence in both time and frequency domains. It was concluded that the efficiency of this artificial BC is more with just meshing the area of the domain of interest.

Falletta and Monegato (2014) proposed a boundary integral equation (BIE) as a local boundary condition defined on an artificial boundary near the area of interest in time domain or frequency domain analysis of the 2D

wave propagation problem. It was reported that such BC is non-reflecting for both types of waves (incoming and outgoing waves) and does not have a requirement of datum supports. The authors did not confirm stability.

A traditional direct boundary integral equation method was proposed by Igumnov et al. (2018) to solve 3D transient loading problems of discretized homogeneous linear elastic solids. Results were compared with those of boundary element scheme and finite element method. They concluded that the boundary element scheme is steady and precise for multi-domain anisotropic elastodynamic problems.

The above-discussed boundary conditions are global in type and provide more accurate results, but they were found to be computationally expensive. Implementation of the above boundary conditions is not easy in finite element programs as compared to local absorbing boundary conditions. Complexity in the application of global boundary conditions causes limited use of the same in finite element programs and their application is selected based on the accuracy requirement of a solution. In the following section, the development and application of local boundary conditions found in the literature are discussed. Dashpot boundary, spring-dashpot and infinite element are local boundary conditions that are frequently used by researchers in the dynamic simulation of soil-structure interaction problems.

Local Non-reflecting Boundary Conditions

Dashpot boundary (i.e., viscous boundary) was introduced by Lysmer and Kuhlemeyer (1969). It is one of the simplest local boundary conditions in time domain. It applies equivalent damping force at the finite boundary to damp out the incoming waves toward the boundary. The equivalent damping force is calculated by using Equation (1). The main idea behind the dashpot boundary is based on the application of viscous damper for the energy dissipation of incoming waves toward the boundary. Dashpots are placed on the boundary of the finite element model to damp out the incoming wave. The calculations of damping coefficients of applied dashpots are carried out by Equation (1) and the physical presentation of the dashpot system is shown in Fig. 1.

$$\left. \begin{aligned} f_n &= -C_p V_n \\ f_t &= -C_s V_t \\ C_p &= \rho V_p \\ C_s &= \rho V_s \end{aligned} \right\} \quad (1)$$

where f_n and f_t are the normal and tangential stresses of the boundary; ρ is the mass density; V_n and V_t are the normal and tangent velocities at the boundary; C_p and C_s are the damping coefficients of dampers applied in the normal and tangential directions of the boundary; V_p and V_s are longitudinal and shear wave velocities.

The main advantage of this BC is that the absorbing dashpots are frequency-independent and the dashpot boundary is equally suitable for harmonic and non-harmonic motions of the wave. A significant limitation of this BC is for low-frequency waves. It provides permanent displacements even in an elastic medium. Many researchers used this BC to take care of radiation damping in the past. Tabatabaiefar et al. (2014) used viscous BC along with free-field motion to study the elastic and inelastic structural behaviors of mid-rise building frames under the influence of SSL.

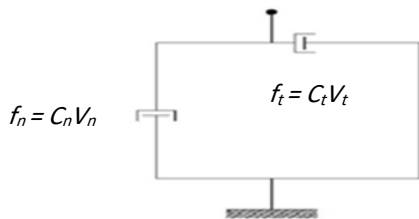

Figure (1): Dashpot element

Various modifications are carried out in standard dashpot boundary condition to overcome the shortcomings of viscous boundary condition. White et al. (1977) provided a new dashpot constant dependent on Poisson’s ratio, which applies to anisotropic materials. This new BC is named as the unified viscous boundary. Later, Akiyoshi (1978) has proposed a new viscous BC for transverse waves and named it as the compatible viscous boundary condition. This BC involves the convolution integral in its formulation and as a result, it loses its own local character.

One vital modification was done using the application of Kelvin elements, as shown in Fig. 2 by Novak and Mitwally (1988). Kelvin element consists of spring-dashpot in a parallel combination and this element is applied at the boundary of a truncated finite domain in FEM analysis. In general, the absorbing

characteristics of Kelvin element at boundaries are mainly governed by dashpots. Therefore, this BC is very similar to the viscous boundary condition, but the addition of the spring provides the soil continuity to the model, which gives advantages over standard dashpot BC.

Spring constant and damping coefficient of Kelvin element are frequency-dependent. Still, these constants are calculated for predominant frequencies and made independent for an interesting frequency bandwidth with some adjustment. The constants of spring and dashpot of Kelvin element in the two horizontal directions were calculated using the solution developed by Novak and Mitwally (1988) and given by Equation (2).

$$k_r = \frac{G}{r_0} [s_{u1}(a_o, \nu, D) + i s_{u2}(a_o, \nu, D)] \quad (2)$$

where k_r is the stiffness of the Kelvin element; G is the shear modulus of soil; S_{u1} and S_{u2} are the dimensionless parameters from closed-form solutions; D is the material damping ratio; ν is Poisson’s ratio; i is the imaginary unit; a_o is the dimensionless frequency ($= r_0 \omega / V_s$, where ω is the excitation frequency and V_s is the shear wave velocity of the soil); and r_0 is the distance in the plan of an FEM model from the center of the foundation to the node where the Kelvin element is attached. The real part of K_r represents the stiffness of the spring, while the imaginary part represents the coefficient of the dashpot.

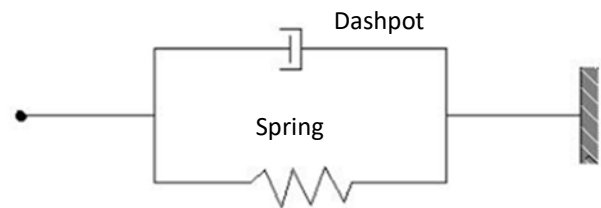

Figure (2): Kelvin element

Maheshwari et al. (2004) applied this Kelvin element in a simulation of the dynamic soil-pile interaction of a single pile and pile groups, using advanced plasticity-based constitutive soil model and hierarchical single surface (HiSS), in the finite element analysis. It was reported that model performance with Kelvin element is satisfactory.

Spring constant of the spring-dashpot system is given by many researchers, like Luco (2004), who developed an expression for the calculation of the average distributed spring constant that is to be placed at the boundaries of a rectangular soil domain of dimensions $2a_x \times 2a_y \times a_z$, as shown in Fig. 3. The average distributed spring constants to be placed at the truncated boundaries are calculated from Equation (3).

$$K_{mn} = \frac{G}{r_m} \beta_{mn} \quad (3)$$

where, k_{ij} = distributed spring constant; G = soil shear modulus; $m = x, y$ or $z =$ plane in which the spring is placed (represented by its normal); $n = x, y$ or $z =$ direction in which the spring acts; $r_m =$ dimension in the m direction; $\beta_{mn} =$ coefficient that depends on Poisson's ratio of the soil and the block dimensions. These coefficients are multiplied with their corresponding influence area of each node in the FE boundary to get a concentrated spring constant.

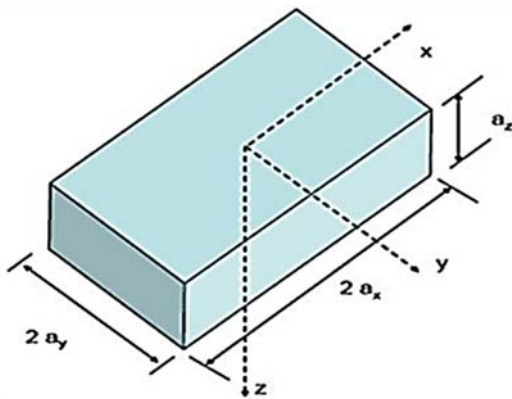

Figure (3): Truncated rectangular 3D soil domain dimensions

Liu et al. (2006) proposed a modified spring constant and damping coefficient of the spring-dashpot system and named it as viscous spring artificial boundary (VSAB) condition and applied it successfully for explosive source problem. The schematic presentation of this VSAB condition is shown in Fig. 4 and the values of the constants are calculated from Equation (4).

$$\left. \begin{aligned} k_1 &= k_2 = \lambda_t \frac{G}{R} A \\ C_1 &= C_2 = \rho v_s A \\ k_3 &= \lambda_n \frac{G}{R} A \\ C_3 &= \rho v_p A \end{aligned} \right\} \quad (4)$$

where k_1, k_2 and k_3 and C_1, C_2 and C_3 are spring and damper constants along X, Y and Z direction, respectively; ρ is mass density; G is the shear modulus of soil; v_s and v_p are shear and longitudinal wave velocities in the soil. R is the distance between seismic load point and boundary. A is the total contribution of an area from surrounding nodes with values equal to $A_1 + A_2 + A_3 + A_4$ for area contribution around the node shown in Fig. 4. λ_n and λ_t stand for the modified constants in the normal and tangential directions of the boundary and their values are listed in Table 1.

Chen et al. (2018) implemented the VSAB boundary condition successfully in the simulation of an undersea tunnel against strong ground motions. A 3D FE model using VSAB BC was compared for predicting the longitudinal seismic response of the subsea shield tunnel.

Zhicheng et al. (2016) used the modified values of λ_n and λ_t and compared the solution with the analytical and extended boundary conditions. It was reported that spring-dashpot provides accurate results with modified constant values of these coefficients.

Bande et al. (2015) evaluated the performance of the SARIYAR dam in the finite element method using ABAQUS for several earthquakes. Viscous boundary condition was used to handle the wave-scattering behavior.

A 2D dam-foundation-reservoir interaction was simulated in the finite element method by Heirany and Ghaemian (2012). Performances of three boundary conditions: viscous BC, boulder dashpot BC (which is similar to viscous BC) and damping BC, were compared for simulation of crack propagation in a dam.

To study the effect of SSI on seismic performance of reinforced concrete moment-resisting frame (MRF), Tomeo et al. (2017) applied the dashpot boundary at the bottom of soil along with tie boundary condition. In the tie boundary condition, left-side boundary and right-side boundary nodes are constrained in such a way that their displacement is equal at the same level.

Mandal and Maity (2016) compared the performance of viscous spring BC, free field and fixed BC with the exact solution (extended mesh) in the numerical simulation of the elastic wave motion in a 2D homogeneous semi-infinite soil domain and it was concluded that local type of NRBC is essential for modeling the dynamic SSI problems containing the small domain of soil.

A coupling method of the finite and infinite elements at their interface acts as a BC to solve the wave radiation problem in infinite soil domain. ABAQUS (Abaqus, 2013) provides 2D and 3D infinite elements that are used by a few researchers (Ismail et al., 2020) in conjunction with the finite elements to analyze the dynamic SSI problem of the semi-infinite soil domain.

Table 1. Coefficient values of λ_n and λ_t

Coefficient	Range of value	Suggested values
λ_n	1.0-2.0	1.33
λ_t	0.5-1.0	0.67

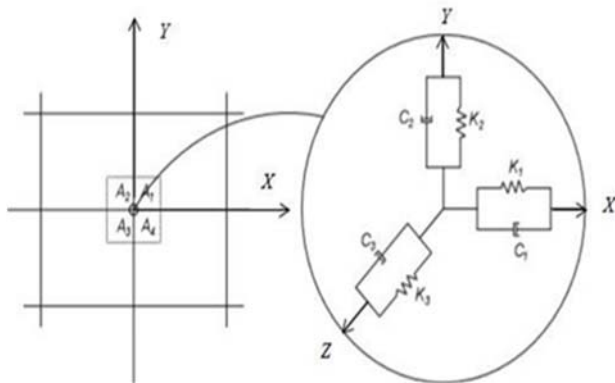

Figure (4): A sketch of VSAB condition

Wang and Al-Qadi (2012) used 3D infinite elements to simulate the dynamic tire loading on the semi-infinite domain of soil. The significance of using a non-linear 3D FEM was shown for the pavement model to model the granular base layer for its response against vehicle dynamic loading. It was reported that the model predicts the trends of field measurements at different loading and temperature conditions using this infinite element as BC.

Bhowmik et al. (2013) simulated a 3D soil-pile interaction system using the infinite element of ABAQUS by applying harmonic excitation in the pile head to estimate the response of pile-soil behavior.

Rave-Arango and Blandón-Urbe (2012) applied 2D infinite element to model the far field of infinite soil domain in the study of plain frame soil-structure interaction problem in the analysis of the effects of earth pressure on the behavior of structures located on slopes under seismic conditions.

This infinite element is not a real element. In reality, it is a kind of application of viscous boundary and as a result, the viscous boundary can be implemented like other finite elements in ABAQUS. CINPS4 and CINPE4 are the 2D infinite elements used for plain stress and plain strain problem. However, ABAQUS also provides CIN3D8 as a 3D infinite element. Fig. 5 shows some linear 3D finite and infinite elements of ABAQUS.

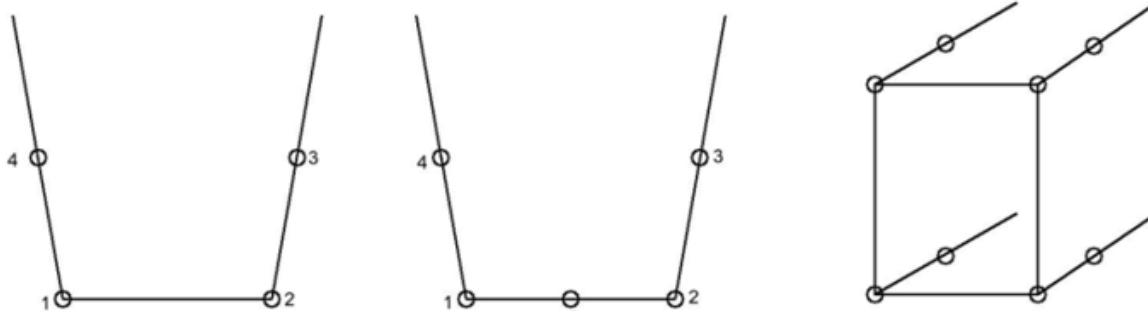

Figure (5): Common linear 2D and 3D infinite elements present in ABAQUS (Manual, 2013)

As discussed above, coupling finite element with infinite element reasonably reflects real boundary condition and gives a unified, simple solving format. It appears that the infinite elements of the far-field soil are part of the finite element model. One of the main advantages of the infinite element in comparison with

other local viscous boundary conditions is that it does not need any other BC to simulate zero displacements at infinity. Therefore, the coupling of the finite element and infinite element can be used as the soil boundary condition to analyze the infinite domain of soil. The above-discussed boundary conditions are the local type

of BC and give efficient results. Still, comparisons of these local boundary conditions in the three-dimensional domain were not made for wave propagation in semi-infinite half-space.

BC NUMERICAL PERFORMANCE FOR LINEAR ELASTIC WAVE MOTION IN SOIL AMPLIFICATION

Finite Element Models

As discussed in the above section, local boundary conditions are easy to implement in the FEM program. This section compares the performance of the widely used efficient spring-dashpot boundary condition (SD) and simple infinite element (CIN3D8) boundary condition (IEL), which is coupled with the finite element, as discussed earlier. The results are compared with a DEEPSOIL software program (DS). In DS, the analysis is performed in time domain and requires a time stepping method that solves the differential equations of motions incrementally between time steps. The soil behaviour is represented by a nonlinear backbone curve coupled with extended Masing rules describing unloading-reloading behaviour. To define the initial backbone curve, the MKZ (Modified, Kondner and Zelasko) model is used. Simplified, full and extended Rayleigh damping formulations, as well as a frequency-independent damping scheme, are implemented in the code. Rigid half space is opted for the assumption that soil below 30 meters is of a rock type.

The response of the two BCs above is studied for two different soil layer systems by simulation in ABAQUS. In this simulation, a large soil domain is used for dynamic free-field behavior simulation of the medium. The mechanical parameters of soil are listed in Table 2. Here, the soil is assumed as an elastic material and stiffness proportional Rayleigh damping is modeled corresponding to 5% soil damping ratio as Mylonakis and Gazetas (2000) used it successfully in the past. Based on the discussion above, the first spring-dashpot system is used as the boundary condition and its stiffness and damping constants are calculated as per calculation done by Luco (2004) for 3D infinite soil domain. The infinite element, coupled with the finite element, is used as the second absorbing boundary condition. It is assumed that the minimum foundation width for a structure is 15 meters. Six times the foundation width is taken as per the suggestion of Kuhlemeyer and Lysmer (1973) for the soil domain. Similarly, recommendations are given for 2D plain strain analysis SSI problem by many researchers, such as Ghosh and Wilson (1971), who observed that the effect of reflected waves is negligible if the boundary is located at 3 to 4 times the equivalent radius of foundation in the horizontal direction and 2 to 3 times for vertical direction. Following this six times, the width rule total length of soil taken was 90 meters to get the proper implementation of the above BC to reduce the wave reflection at the boundary.

Table 2. Soil parameters used in modeling the soil domain

Description of parameters	Single-layer system (S1)	Two-layer system (S2)	
		Upper Layer	Lower Layer
Young's modulus (MPa)	20	20	40
Poisson's ratio	0.4	0.4	0.4
Mass density(kg/m ³)	1203	1203	1600
Shear wave speed (m/s)	77	77	94
Layer depth (m)	0-30	0-15	15-30

In the simulation of wave propagation in the soil, the element size affects the response of soil if it is not selected properly. The selection of appropriate element size (Δx) and time-step (Δt) size is generally based on the simple rule, as suggested by Lysmer and Kuhlemeyer (1969). They suggested that the ratio of the length of the side of the largest element and the

minimum wavelength (λ_{min}) of elastic waves propagating in the soil should be less than 1/12-1/8. Considering this rule in mind, maximum element length is selected considering this ratio as 1/10. Therefore, the maximum element size is calculated using Equation (5) and the maximum frequency (f_{max}) of interest considered in this calculation is 10Hz. On the other

hand, the time step size is calculated as per Equation (6) to ensure the accuracy and stability of simulation, as suggested by Nilsson and Jones (2007).

$$\Delta x = \frac{\lambda_{min}}{10} = \frac{v_s}{10f_{max}} \quad (5)$$

$$\Delta t = \frac{\Delta x}{v_p} \quad (6)$$

where v_s and v_p are longitudinal and shear wave velocity, respectively.

The soil element of the finite domain is modeled with

the C3D8 element in both cases of considered BC. At the same time, CIN3D8 is used as the infinite element to model the far field in the case of coupled infinite element BC. Finite element meshed models with both types of BC are shown in Fig. 6 for soil profile S1. To develop an efficient model, the most practical soil condition and some less prominent factors are considered in this simulation. It is also assumed that each layer of soil is homogeneous and extended to infinity. There is no sliding between soil layers and earthquake motion is coming from beneath the foundation, as suggested by Novák and Beredugo (1972).

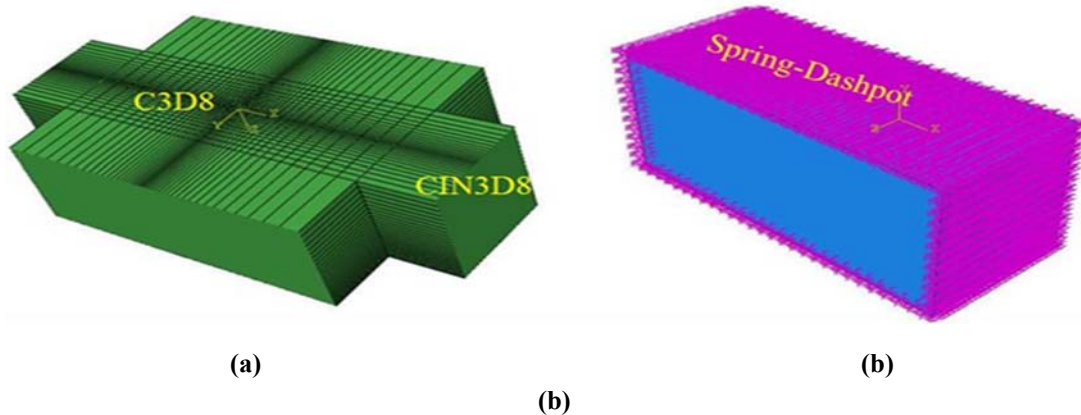

Figure (6): Screenshot of 3D finite element model for soil profile S1 with (a) infinite element and (b) viscous spring BC

Since the free-field response of soil depends upon the pre-stress condition of the soil, so to simulate pre-stress condition, the geostatic step is first applied in the analysis, followed by the implicit step for seismic input loading.

Validation of free-field motion was completed in both frequency domain and time domain. Validation in the frequency domain was carried out to ensure the proper ground motion behavior at various frequencies. Time-domain validation was completed to guarantee that it gives the actual conduct under an actual seismic excitation, in which the wave is formed with the combination of different frequencies. Validation of infinite element BC in the frequency domain analysis is considered in this study as spring-dashpot BC, which has been used by various researchers, as discussed earlier.

Frequency-domain Analysis

In frequency analysis, a soil column of ten-meter

height is modeled with an elastic modulus of 20MPa, a density of 1203 kg/m³ and a Poisson's ratio of 0.4. The damping ratio was assumed to be 5% and the soil was considered to behave linear-elastically throughout the analysis. Infinite elements are attached at the lateral boundaries of the model. Then, a sinusoidal excitation was given at the base of the soil column, which is described by Equation (7).

$$X(t) = A \sin(\omega t) \quad (7)$$

where A is the amplitude, ω is the angular frequency and t is time. The frequency-domain range taken in this analysis is 1Hz to 10 Hz, because the dominant frequency is less than 10Hz. The response was obtained for the frequency range and amplification was estimated by taking the ratio of free-field amplitude to input amplitude. Amplification obtained from the numerical simulations was compared with the theoretical value of amplification calculated using Equation (8), as

suggested by Gazetas (1984) for one-dimensional wave propagation, as shown in Fig. 7.

$$\frac{U_g}{U_0} = \frac{1}{\cos(qh)} \quad (8)$$

where

$$q = \frac{2\pi f}{v_s \sqrt{1+2iD}}$$

- U_0 = amplitude of the input bedrock displacement.
- U_g = amplitude of the free-field ground displacement.
- h = height of the soil stratum.
- f = frequency of the input motion.
- v_s = shear wave velocity of the soil.
- D = damping ratio.

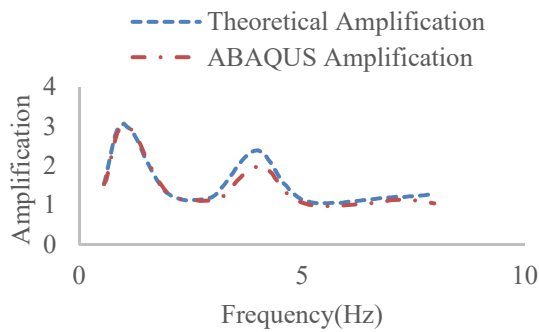

Figure (7): Free-field motion in the frequency domain

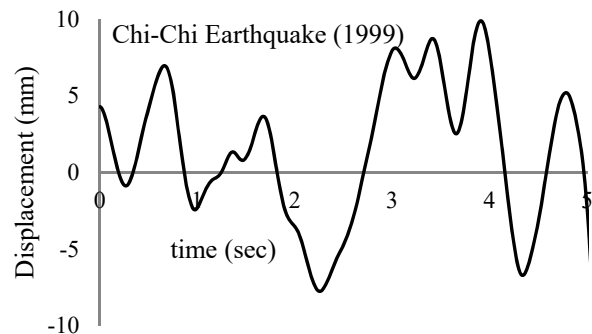
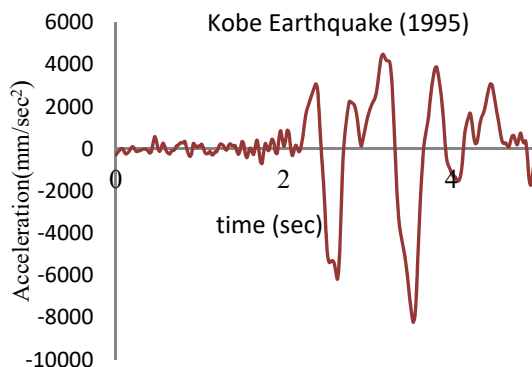

Figure (8): A portion of the Kobe earthquake (1995) and Chi-Chi earthquake (1999) time-history

Time-domain Analysis

Validation for free-field response is carried out by using two seismic ground excitations. For this purpose, a portion of selected earthquakes (Peiris et al., 2014) of Kobe (1995) and Chi-Chi (1999) earthquakes, is used in both soil models (Fig. 8). Kobe earthquake motion is applied as an acceleration time history for both soil types S1 and S2. In contrast, Chi-Chi earthquake is used as a displacement time history for soil S1 type to check the BC performance with different seismic motions.

RESULTS AND DISCUSSION

After the completion of numerical analyses, results were examined and free-field response of soil values was obtained for the different seismic inputs, as discussed earlier. In order to compare the performance of different boundary conditions, free-field responses for spring-dashpot and infinite element method boundary conditions are presented on the same curve along with the response obtained from commercial DEEPSOIL software for Kobe (1995) and Chi-Chi (1999) earthquakes. Figs. 9, 10 and 11 show the efficiency of the above discussed two waves absorbing boundary in free-field response analysis of the two soil types; namely S1 and S2. Acceleration time history response at the top of the soil is compared with the result of geotechnical commercial software DEEPSOIL. It is evident from the results that all three simulations give almost similar results.

Hence, it can be concluded that infinite elements can be used as energy-absorbing boundaries with similar effects as the spring/dashpot boundaries.

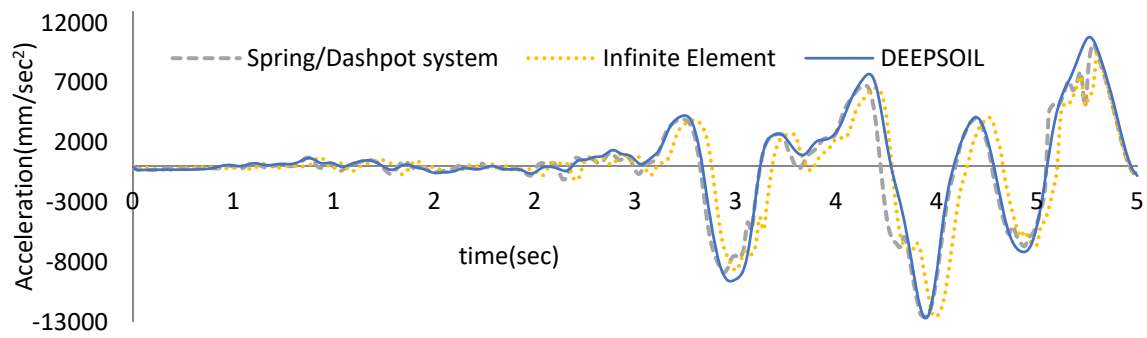

Figure (9): Free-field response performance of BCs for soil type S1 to the Kobe earthquake (1995)

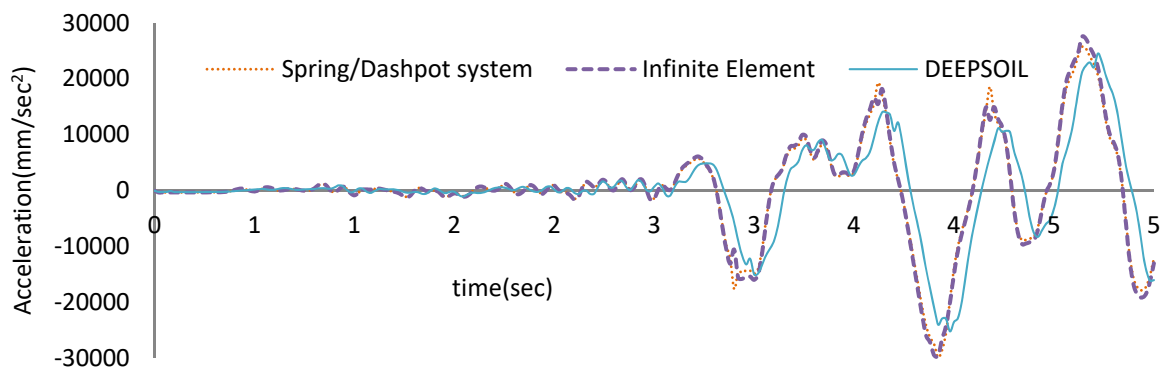

Figure (10): Free-field response performance of BCs for soil type S2 to the Kobe earthquake (1995)

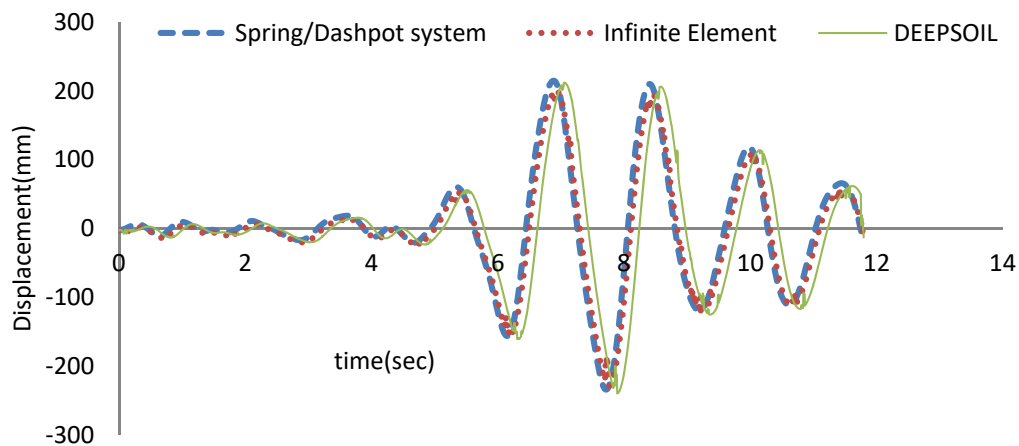

Figure (11): Comparison of BCs for S1 soil type to Chi-Chi earthquake (1999)

SUMMARY AND CONCLUSIONS

To simulate the soil-structure interaction problem using the finite element technique effectively, simple and precise three-dimensional artificial waves absorbing

boundary conditions at the truncated boundary of semi-infinite and infinite soil domain are very important. Keeping the importance of artificial boundary conditions in mind, a detailed critical review of the modeling techniques of boundary conditions and

comparisons of the performance of these BCs for amplification on soft semi-infinite soil deposits are performed.

A detailed review of elementary, global and local boundary conditions found in the literature is carried out. It is observed that spring-dashpot boundary condition is a widely used BC to take care of radiation damping while solving the SSI problem. The two widely used local boundary conditions: infinite element and spring-dashpot BCs, are compared with DEEPSOIL software for the free-field response of two types of soil for two different seismic inputs. It is observed that the infinite element boundary condition is as good as the widely used spring-dashpot boundary condition in 3D FEM programs.

The infinite element boundary condition in ABAQUS is utilized for different types of dynamic analysis; i.e., steady-state dynamic frequency-domain analysis, direct integration implicit dynamic response analysis and explicit dynamic analysis. Infinite

boundary condition presents “quit” boundaries to FEM models for each of the dynamic analysis discussed above. The static force, at the start of the dynamic response, remains unchanged on the boundary; as a result, far-field nodes do not give any displacement during the analysis. This technique minimizes the hitches faced in the use of conventional methods and utilizes lesser space and lesser computational time. The significant benefit of infinite element BC is that it does not require other lateral support at the interface, as it is done in spring-dashpot BC to support the truncated boundary of soil. The paper finds that the infinite element can be conveniently applied for dynamic analysis. It takes lesser computational time and can also be used in conjunction with the regular element of FEM.

ACKNOWLEDGEMENT

The authors would like to acknowledge the financial support provided by the Indian Institute of Technology Patna, India.

REFERENCES

- Abaqus. (2013). "6.13 analysis user's manual." SIMULIA, Providence, IR.
- Akiyoshi, T. (1978). "Compatible viscous boundary for discrete models." *Journal of the Engineering Mechanics Division*, 104 (5), 1253-1266.
- Alfach, M. (2012). "Influence of soil plasticity on the seismic performance of pile foundations: A 3D numerical analysis." *Jordan Journal of Civil Engineering*, 6 (1), 1-16.
- Appelö, D. (2003). "Non-reflecting boundary conditions for wave propagation problems. PhD Thesis. Stockholm, Royal Institute of Technology, Sweden, 44.
- Bandei, F., Azizian, G., and Golbarari, M.H. (2015). "Displacement of gravity dam in far and near fault earthquake including dam-water-sediment-foundation interaction". *Current World Environment*, 10, 955-966.
- Bhowmik, D., Baidya, D., and Dasgupta, S. (2013). "A numerical and experimental study of hollow steel pile in layered soil subjected to lateral dynamic loading." *Soil Dynamics and Earthquake Engineering*, 53, 119-129.
- Chen, G., Ruan, B., and Zhao, K. et al. (2018). "Nonlinear response characteristics of undersea shield tunnel subjected to strong earthquake motions". *Journal of Earthquake Engineering*, 1-30.
- Davies, T., and Bu, S. (1996). "Infinite boundary elements for the analysis of halfspace problems." *Computers and Geotechnics*, 19 (2), 137-151.
- Falletta, S., and Monegato, G. (2014). "An exact nonreflecting boundary condition for 2D time-dependent wave equation problems." *Wave Motion*, 51 (1), 168-192.
- Far, H. (2017). "Advanced computation methods for soil-structure interaction analysis of structures resting on soft soils." *International Journal of Geotechnical Engineering*, 1-8.
- Gazetas, G. (1984). "Seismic response of end-bearing single piles." *International Journal of Soil Dynamics and Earthquake Engineering*, 3 (2), 82-93.
- Ghosh, S., and Wilson, E.L. (1971). "Dynamic stress analysis of axisymmetric structures under arbitrary loading". Report No. EERC 69-10, Earthquake Engineering Research Center, University of California, Berkeley, California.

- Givoli, D. (2004). "High-order local non-reflecting boundary conditions: A review." *Wave Motion*, 39 (4), 319-326.
- Givoli, D., and Neta, B. (2003). "High-order non-reflecting boundary scheme for time-dependent waves." *Journal of Computational Physics*, 186 (1), 24-46.
- Hashash, Y., Groholski, D., Phillips, C., Park, D., and Musgrove, M. (2011). "DEEPSOIL 5.0, user manual and tutorial." University of Illinois, Urbana, IL, USA.
- Heirany, Z., and Ghaemian, M. (2012). "Effect of foundation in dynamic analysis of concrete gravity dams." *Gradevinar*, 64 (8), 641-646.
- Higdon, R.L. (1986). "Absorbing boundary conditions for difference approximations to the multidimensional wave equation." *Mathematics of Computation*, 47 (176), 437-459.
- Igunnov, L., Markov, I., and Litvinchuk, S.Y. (2018). "Boundary element modeling of dynamic behavior of piecewise homogeneous anisotropic elastic solids". *Journal of Physics: Conference Series*, IOP Publishing.
- Ismail, S., Kaddah, F., and Raphael, W. (2020). "Seismic soil-structure interaction response of mid-rise concrete structures on silty sandy soil". *Jordan Journal of Civil Engineering*, 14 (1).
- Jingbo, L., and Du Yixing, Y.Q. (2007). "The implementation of viscoelastic artificial boundary and the ground motion input in the general finite element software." *Journal of Disaster Prevention and Mitigation Engineering*, 27 (4), 37-42.
- Karpurapu, G.R. (1988). "Composite infinite element analysis of unbounded two-phase media". *Advances in Engineering Software*, 10 (4), 202-209.
- Kazakov, K. (2011). "Formulation of elastodynamic infinite elements for dynamic soil-structure interaction". *WSEAS Transactions on Applied and Theoretical Mechanics*, 6 (1), 91-96.
- Kuhlemeyer, R.L., and Lysmer, J. (1973). "Finite element method accuracy for wave propagation problems". *Journal of Soil Mechanics & Foundations Div.*, 99 (Tech. Rpt.).
- Liu, J., Du, Y., Du, X., Wang, Z., and Wu, J. (2006). "3D viscous-spring artificial boundary in time domain." *Earthquake Engineering and Engineering Vibration*, 5 (1), 93-102.
- Luco, J. (2004). "Approximate external boundaries for truncated models of unbounded media". 3rd UJNR Workshop on Soil-Structure Interaction, Menlo Park, California, USA.
- Lysmer, J., and Kuhlemeyer, R. L. (1969). "Finite dynamic model for infinite media." *Journal of Engineering Mechanics Division*, 95 (4), 859-878.
- Maheshwari, B., Truman, K., El Naggar, M., and Gould, P. (2004). "Three-dimensional nonlinear analysis for seismic soil-pile-structure interaction." *Soil Dynamics and Earthquake Engineering*, 24 (4), 343-356.
- Mandal, A., and Maity, D. (2016). "Study of local non-reflective boundary condition on soil domain." *Procedia-Engineering*, 144, 1252-1259.
- Manual, A.U. (2013). "Version 6.13-2." Dassault Systèmes Simulia Corp., Providence, Rhode Island, USA.
- Matinmanesh, H., and Asheghabadi, M.S. (2011). "Seismic analysis on soil-structure interaction of buildings over sandy soil." *Procedia-Engineering*, 14, 1737-1743.
- Medina, F. (1992). "Modelling of layered soil-structure interaction by infinite elements". *Proceedings of the 10th World Conference on Earthquake Engineering*, Madrid.
- Mulder, W. (1997). "Experiments with Higdon's absorbing boundary conditions for a number of wave equations". *Computational Geosciences*, 1 (1), 85.
- Mylonakis, G., and Gazetas, G. (2000). "Seismic soil-structure interaction: Beneficial or detrimental?" *Journal of Earthquake Engineering*, 4 (3), 277-301.
- Neta, B., van Joolen, V., Dea, J.R., and Givoli, D. (2008). "Application of high-order Higdon non-reflecting boundary conditions to linear shallow water models." *Communications in Numerical Methods in Engineering*, 24 (11), 1459-1466.
- Nilsson, C.-M., and Jones, C.J. (2007). "Theory manual for WANDS 2.1 wave number domain FE-BE software for structures and fluids."
- Novák, M., and Beredugo, Y.O. (1972). "Vertical vibration of embedded footings." *Journal of Soil Mechanics & Foundations Div.*, 98 (Sm 11).
- Novak, M., and Mitwally, H. (1988). "Transmitting boundary for axisymmetrical dilation problems." *Journal of Engineering Mechanics*, 114 (1), 181-187.
- Peiris, T., Thambiratnam, D., Perera, N., and Gallage, C. (2014). "Soil-pile interaction of pile embedded in deep-layered marine sediment under seismic excitation." *Structural Engineering International*, 24 (4), 521-531.

- Rajagopal, P., Drozd, M., Skelton, E.A., Lowe, M. J., and Craster, R.V. (2012). "On the use of absorbing layers to simulate the propagation of elastic waves in unbounded isotropic media using commercially available finite element packages." *NDT & E International*, 51, 30-40.
- Rave-Arango, J., and Blandón-Uribe, C. (2012). "Structural response of buildings on mountain slopes subjected to earth pressure under seismic conditions." *Engineering Structure*, 28, 11-19.
- Samii, A., and Lotfi, V. (2012). "Application of H–W boundary condition in dam–reservoir interaction problem." *Finite Elements in Analysis and Design*, 50, 86-97.
- Smith, W.D. (1974). "A non-reflecting plane boundary for wave propagation problems." *Journal of Computational Physics*, 15 (4), 492-503.
- Su, J., and Wang, Y. (2013). "Equivalent dynamic infinite element for soil–structure interaction." *Finite Elements in Analysis and Design*, 63, 1-7.
- Tabatabaiefar, S., Fatahi, B., and Samali, B. (2014). "An empirical relationship to determine lateral seismic response of mid-rise building frames under influence of soil–structure interaction." *Structural Design of Tall and Special Buildings*, 23 (7), 526-548.
- Tabatabaiefar, S.H.R. (2016). "Detail design and construction procedure of laminar soil containers for experimental shaking table tests." *International Journal of Geotechnical Engineering*, 10 (4), 328-336.
- Tomeo, R., Bilotta, A., Pitilakis, D., and Nigro, E. (2017). "Soil-structure interaction effects on the seismic performance of reinforced concrete moment-resisting frames." *Procedia-Engineering*, 199, 230-235.
- Underwood, P., and Geers, T. (1981). "Doubly asymptotic, boundary-element analysis of dynamic soil-structure interaction." *International Journal of Solids and Structures*, 17 (7), 687-697.
- Villamizar, V., Acosta, S., and Dastrup, B. (2017). "High-order local absorbing boundary conditions for acoustic waves in terms of farfield expansions." *Journal of Computational Physics*, 333, 331-351.
- Wang, H., and Al-Qadi, I.L. (2012). "Importance of nonlinear anisotropic modeling of granular base for predicting maximum viscoelastic pavement responses under moving vehicular loading." *Journal of Engineering Mechanics*, 139 (1), 29-38.
- White, W., Lee, I.K., and Valliappan, S. (1977). "Unified boundary for finite dynamic models." *Journal of Engineering Mechanics Division*, 103 (5), 949-964.
- Wolf, J.P., and Song, C. (1996). "Finite-element modeling of unbounded media". Wiley Chichester.
- Yun, C.B., Chang, S., Seo, C., and Kim, J. (2007). "Dynamic infinite elements for soil-structure interaction analysis in a layered soil medium." *International Journal of Structural Stability and Dynamics*, 7 (4), 693-713.
- Yun, C.B., Kim, J.M., and Hyun, C.H. (1995). "Axisymmetric elastodynamic infinite elements for multi-layered half-space". *International Journal for Numerical Methods in Engineering*, 38 (22), 3723-3743.
- Zhao, M., Du, X.-l., and Liu, J. (2012). "A high-order accurate artificial boundary condition: Out-of-plane exterior wave problem." *Engineering Mechanics*, 29 (4), 14.
- Zhicheng, X., Qiang, P., Shuang, W., and Changfeng, P. (2016). "Input seismic motion based on the viscous-spring boundary: Analytical solution and numerical simulation". *International Journal of u-and e-Service, Science and Technology*, 9 (6), 59-68.