

Study of the Effect of Steam Injection on Crude Oil Displacement Yield from an Oil Contaminated Soil Bed

Mamdouh A. Allawzi¹⁾ and Nabil Al-Jarrah¹⁾

¹⁾ Chemical Engineering Department, Jordan University of Science and Technology, P.O. Box 3030 Irbid 22110, Jordan
Corresponding Author: mallawzi@just.edu.jo

ABSTRACT

A substantial oil recovery of different packed soil samples has been obtained by the removal of light and heavy crude oils, with different American Petroleum Institute (API) gravity indexes. Steam and water injection methods are applied to different soil particle size samples (core size) and different types of oil gravity. The amount of oil removed increases with increasing the core size (permeability and porosity). For 0.5 mm core size and light oil (35-API), oil recovery reaches 98 wt% using superheated steam and 96 wt% using saturated steam. For heavy oil (24-API), oil recovery reaches 91 wt% using superheated steam and 90 wt% using saturated steam.

For 0.2mm core size and heavy oil (24-API), oil recovery reaches 85% using superheated steam and 74 wt% using saturated steam. These results suggest that oil recovery increases as cell temperature and core size (permeability and porosity) increase, and the addition of surfactants to steam increased oil recovery amounting to around 3 wt%. Water injection resulted in low oil recovery, and the maximum oil recovery is 5 wt%, and 20 wt% using cold and hot water, respectively.

KEYWORDS: Remediation, Crude oil, Steam injection, Hot water injection, Surfactants.

INTRODUCTION

Environmental pollution is currently one of the most important issues facing humanity. It has increased exponentially over the past few years and is reaching alarming proportions in terms of its effect on living creatures. Hydrocarbon compounds are considered among the pollutants that have a direct effect on man and animals as they contaminate soil and groundwater resources leading to a serious groundwater pollution problem. Therefore, removing these compounds or decreasing their concentrations to the permitted levels is becoming a challenging issue.

The application of thermal methods for crude oil production is well known in petroleum engineering as part of Enhanced Oil Recovery (EOR). The importance of

the EOR method to produce additional oil can hardly be over-emphasized. The EOR method can be divided into two major groups; namely thermal processes and chemical flooding processes. The *in-situ* combustion (wet and dry), hot water and steam injection methods fall into the first category, whereas CO₂ flooding, surfactant flooding and polymer flooding fall into the second category (Schumacher, 1982).

Willman et al. (1961) estimated laboratory studies of oil recovery from a petroleum reservoir by steam injection. They studied the recovery of oil by cold water, hot water and steam injection. Different cylindrical cores of several sizes with different oils were used. Different cell dimensions with different permeabilities were studied. They found that both hot water injection and steam injection recover more oil than ordinary water flood. Steam injection results in a significantly greater recovery of crude oil than a hot water flood does because

steam distillation and related gas drive is added to viscosity reduction and swelling as recovery mechanisms. It was also found that high pressure (and temperature) saturated steam is more effective than low-pressure steam, because all the recovery mechanisms are enhanced at high temperature.

Thermally enhanced remediation technologies are promising for the removal of contaminants at heavily contaminated sites (Heron et al., 2005). The methods include injection of hot air, hot water or steam; thermal conduction using heat blankets or thermal wells; low-frequency electrical heating; radio frequency heating; microwave heating; and/or combinations of such methods (Davis, 1997; Heron et al., 1998; Smith and Hinchee, 1993).

The main reason for the wide application of thermal treatment is that the mobility of the contaminant increases at elevated temperatures (Davis, 1997; Davis, 1998). The single most important removal mechanism is increased vapor pressure. Vapor pressure is a measure of volatility of a compound when it is present as a free phase liquid. The high temperature dependence of vapor pressure leads to an increased fraction of the contaminants in the gas phase which increases the ease of extracting contaminants in soil vapor (Heron et al., 1998; Stewart and Udell, 1988).

Steam injection, also termed steam enhanced extraction, was initially developed by the petroleum industry for enhancing oil recovery, and has more recently been adapted to remediate soil and aquifers (Davis, 1997; Udell and Stewart, 1989). Steam injection has been applied at some sites in the USA (USEPA, 2004). It has been applied in unsaturated as well as saturated zones (Smith and Hinchee, 1993) and is generally more efficient in porous media such as sand (Heron et al., 1998) than in low permeable soils (Balshaw-Biddle et al., 2000).

The use of surfactants to form foam flow with gas injection in porous media has shown that foam proves effective in controlling gas mobility in layered porous media (Kovseck et al., 1997; Apaydin et al., 2000). A steam/non-condensable gas foam formulation was

developed to reduce steam mobility in the steam drive process as applied to heavy oil reservoirs with little or no dip such as the Kern River field (Dilgeren and Owens, 1982). Usage of steam for mobility control for steam injection shows an increase in the oil recovery (Siddiqui, et al., 2002). Thermal degradation and adsorption of surfactants used in enhanced oil recovery has been studied where the degradation rate and level of adsorption onto petroleum reservoir rocks are determined (Allawzi and Patton, 1994).

The objective of this study is to investigate the effect of injected water and steam, with and without surfactant, on the crude displacement or recovery efficiency from soil.

SAMPLE ANALYSIS AND SETUP

Preparation and Analysis of Samples

Soil samples formed mainly from dolomite and limestone obtained from the eastern Jordan area of Azraq were crushed using a jaw crusher with samples separated according to their size. A set of standard screens were arranged serially in a stack, with the largest mesh at the top and the smallest at the bottom. Each size corresponding to sieve #35 and 70 was put in a separate container labeled with its size. The soil sample is packed in the cell which has the following dimensions: length = 19cm, diameter = 4.5 cm and cross section area = 15.904cm².

Porosity Determination

The porosity of the sand bed was determined by a method used for petroleum core bed where a brine solution of 3% NaCl is injected through the bed. At a low flow rate, a brine solution was pumped through the packed soil bed for one hour, and then the cell was saturated for 24 hours. Then the brine solution was displaced from the cell by pumping ethanol solution. The brine and ethanol discharged from the cell were collected, and then ethanol and water were evaporated. The dried NaCl was weighed and the amount and volume of brine solution was calculated based on the original NaCl concentration. The volume of brine solution calculated is

equal to the pore volume and since the bulk volume is known from the cell dimensions, the porosity was calculated.

Permeability Determination

The permeability of the sample was calculated using Darcy's Law in Equation 1.

$$K = \frac{Q \mu L}{A \Delta P} \quad (1)$$

where the permeability, K (Darcy) is equal to the product of the total discharge, Q (cm³/s), the viscosity μ (cp), and the length of cell L (cm), all divided by the cross section area to flow, A (cm²) and pressure drop, ΔP .

Table (1): Crude Oil Properties.

Oil Type	API	Specific Gravity	v @ 25 °C (cm ² /s)	v @ 100°C (cm ² /s)	v @160°C (cm ² /s)
1	24	0.91	48 x 10 ⁻²	8 x 10 ⁻²	3.6 x 10 ⁻²
2	35	0.85	8 x 10 ⁻²	2.7 x 10 ⁻²	2 x 10 ⁻²

Table (2): Properties of Core Samples.

Particle Size (mm)	Sieve #	Pore Volume (ml)	Porosity (%)	Permeability, cp·cm ² /atm·s
0.20	70	78.0	24.0	10.35
0.50	35	85.0	29.0	13.54

For each run, the packed soil bed was prepared with the required fixed amount of certain soil size and the required amount and type of oil. The initial oil was 54 grams. They were thoroughly mixed in order to obtain a homogenous mixture; the mixture was then packed in the cell. A metal mesh was installed at the end of the packed bed holder to prevent core losses during flow. A digital thermocouple was connected at the cell edge with the sample then connected to the apparatus. The samples were analyzed and the oil properties are shown in Table 1. The core material sieve #, porosity and permeability were tested and are shown in Table (2).

Procedure and Apparatus for Steam Injection

The experimental set-up used for steam injection is shown in Figure 1. The cold, hot, and surfactant solutions were placed in a tank, then injected through the packed bed using a centrifugal pump. The saturated steam was obtained from a boiler and a steam trap was placed at the up-stream side of the cell. Steam is allowed to flow

through the line in order to heat the line and release the condensate. The injection rate was controlled by adjusting pressure at the inlet valve. Superheated steam was obtained by heating the saturated steam in a heater, where the temperature of the saturated steam is increased to become superheated. Oil is displaced from the cell to a condenser and a separator, where the water and oil produced are collected in a funnel. Oil is then separated from water by gravity. The yield was calculated by subtracting the initial oil from the displaced oil as shown in Equation 2. A similar procedure is performed for cold and hot water injection.

$$Yield = \frac{Initial\ oil - Produced\ oil}{Initial\ oil} 100\% \quad (2)$$

RESULTS

Results of Oil Removal Based on Steam Injection

The steam injection process was studied by injecting

saturated and superheated steam into the cell using different types of oil with different core sizes. Figure 2 shows the oil recovery performance when the core bed was injected with saturated steam at 125°C, where recovery reaches 95%. Results are based on the injection of two different steam flow rates into the bed containing

0.5 mm core size and light oil (35-API). Results for the highest flow rate indicate an early oil recovery, where almost 75% of oil was recovered in a short period of time corresponding to one-third of the Pore Volume (PV) injected.

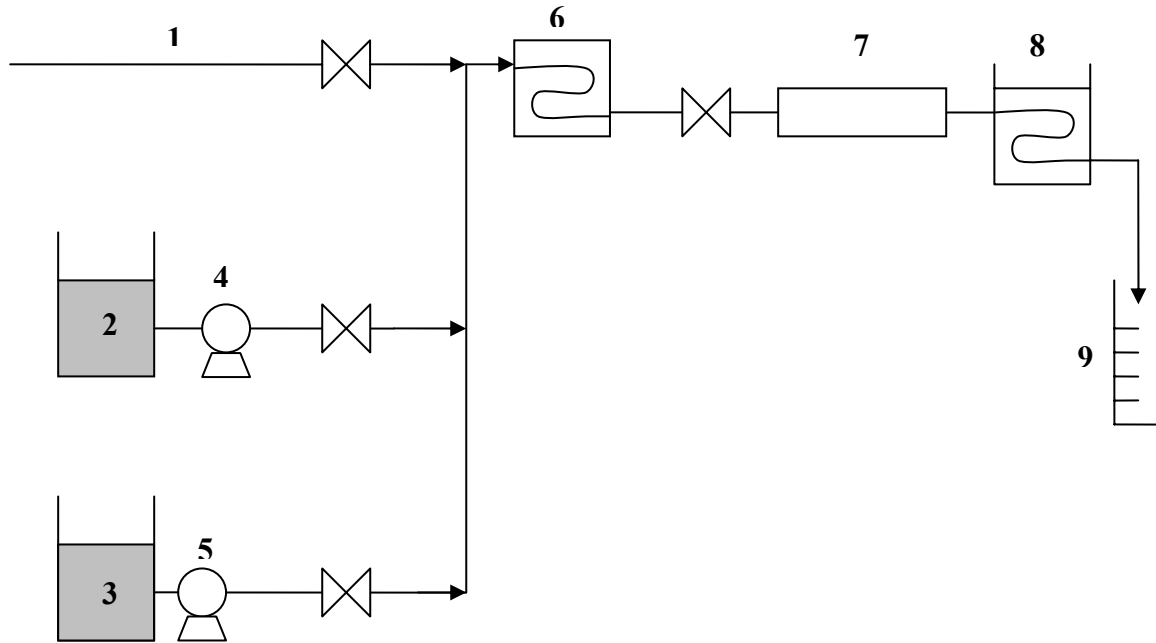

1: Steam from boiler, 2 and 3: Cold and hot water vessels, 4 and 5: Centrifugal pumps, 6: Heater, 7: Soil cell, 8: Ice condenser, 9: Graduated cylinder

Figure (1): Apparatus for remediation of oil from the contaminated soil sample.

At the higher flow rate of steam (41 ml/min), an early breakthrough of oil occurred due to the high pore volume of steam injected through the cell bed (high velocity). While at the lower steam flow rate (11.8 ml/min), it takes longer to achieve a breakthrough. As a result, the amount of recovery will be delayed. Looking at the total recovery for both flow rates, we can see that at the low flow rate, recovery is higher than that at the high flow rate. At a high flow rate, steam will penetrate through the bed and channeling may occur through various locations in the bed. This, in turn, causes the steam to flow through these

channels and achieve lower recovery since the area contacted by steam will be less than that at the low flow rate. So, at a low flow rate, high sweep efficiency will be achieved. We can see that at a low flow rate, extra 10% oil is recovered than that is recovered at a high flow rate.

For 0.5mm core size and heavy oil (24-API), the test was conducted at two different steam flow rates. Figure 3 shows the results for the different steam flow rates. From these figures, we can see that the flow rate effect on oil recovery has similar behavior as that for the light oil. But the recovery is lower than that for light oil. Figure 4

shows oil recovery for two different types of oil (light and heavy) at equal flow rates of steam. From this figure, it can be seen that light oil, which has a lower viscosity, has an early recovery, while heavy oil, which has a high viscosity, has a delay in recovery. For the amount of steam injected, heavy oil needs a larger amount of steam

(higher amount of heat) to recover oil, since the viscosity of heavy oil is higher than that for light oil. 5.9PV of steam as a condensate water was injected to recover 96% of light oil. On the other hand, 8.4 PV of steam was injected to recover 90% of heavy oil.

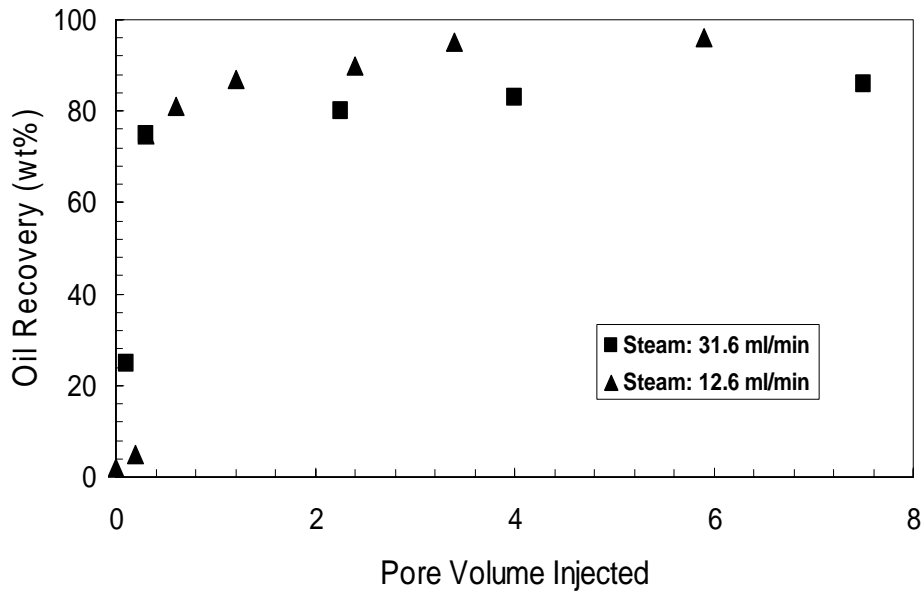

Figure (2): % Oil recovery versus PV for 0.5mm core size and light oil (35-API).

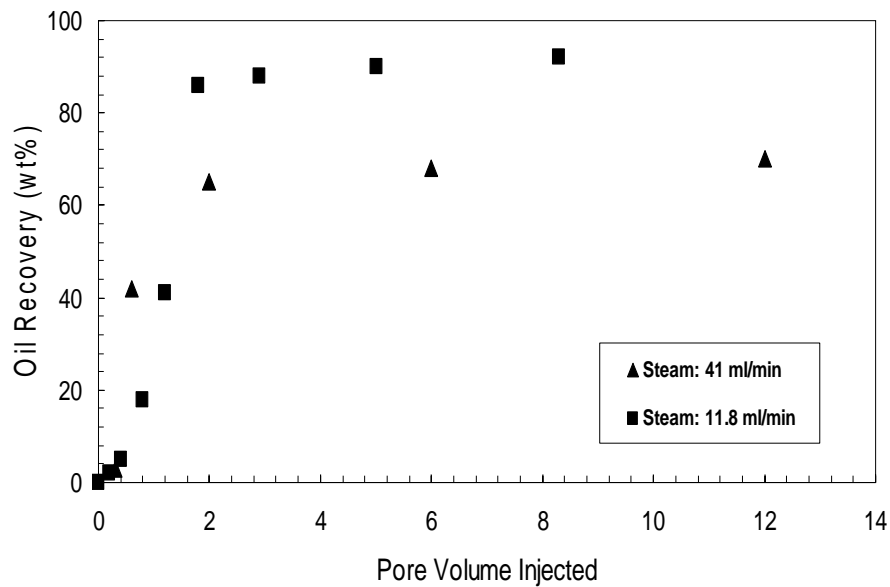

Figure (3): % Oil recovery versus PV for 0.5mm core size and heavy oil (24-API).

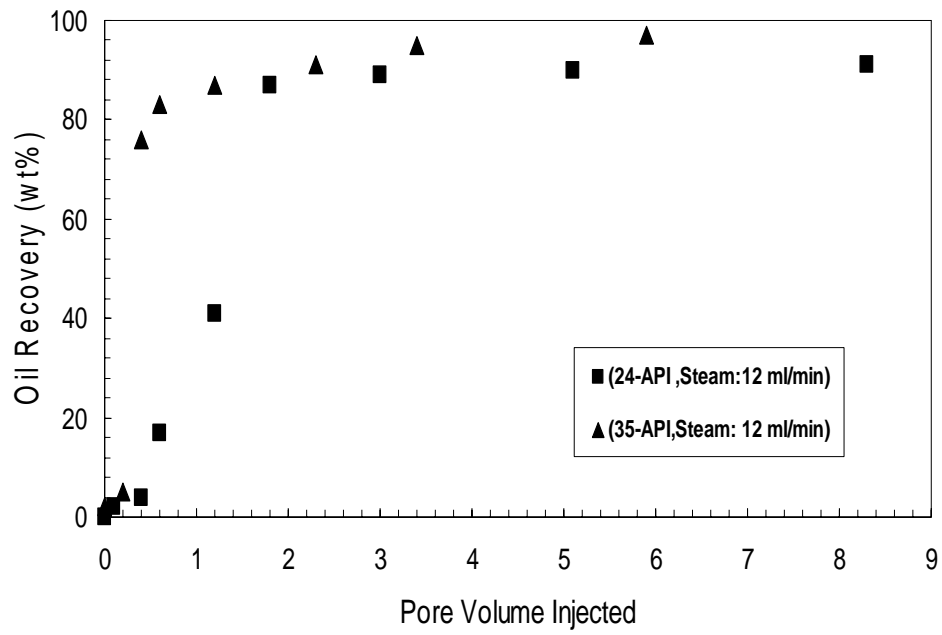

Figure (4): % Oil recovery versus PV for 0.5mm core size with different oil types.

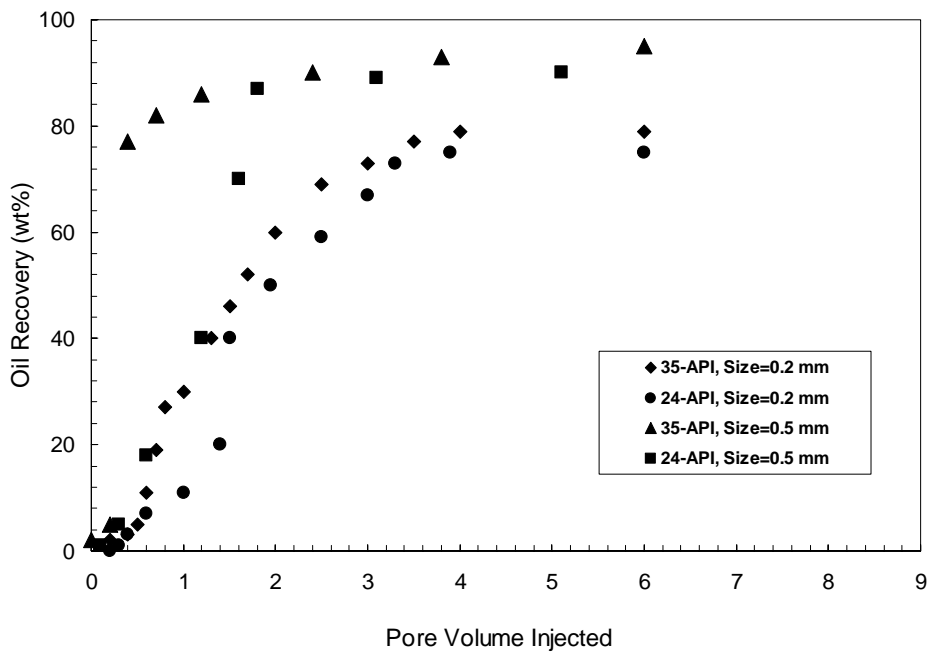

Figure (5): % Oil recovery versus PV for different core sizes with different oil types.

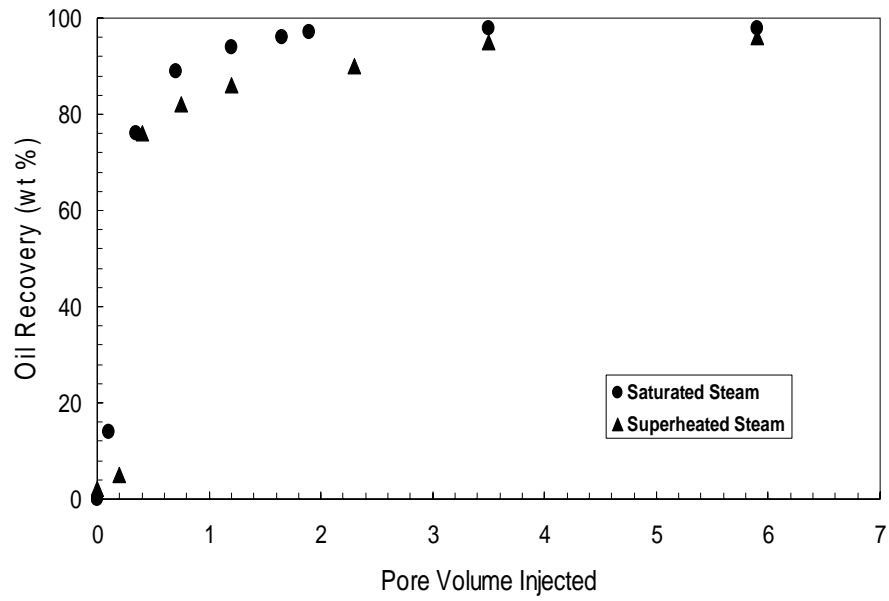

Fig. (6): % Oil recovery versus PV for 0.5mm core size and light oil.

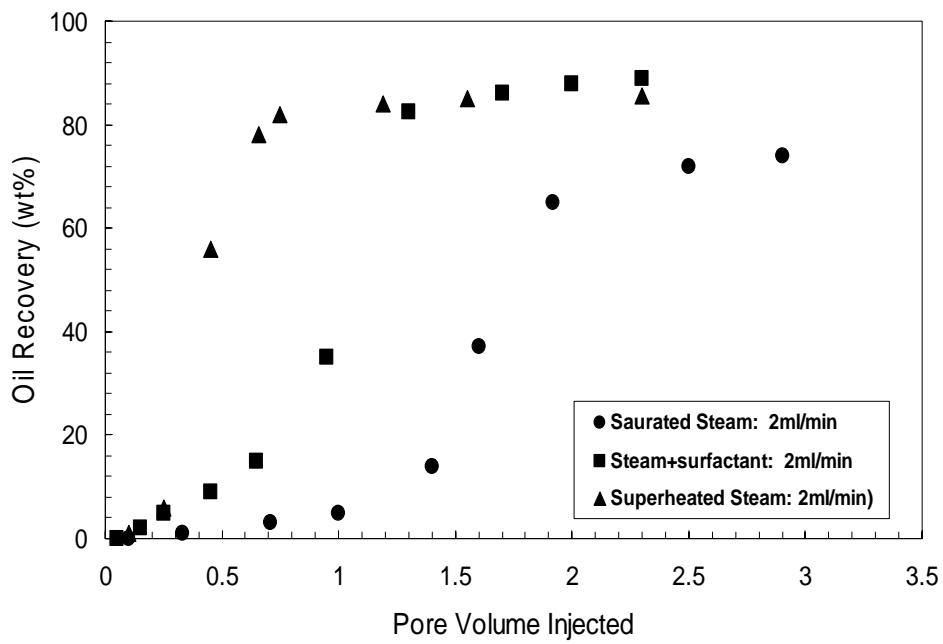

Fig. (7): % Oil recovery versus PV for 0.2mm core size and heavy oil using different types of steam.

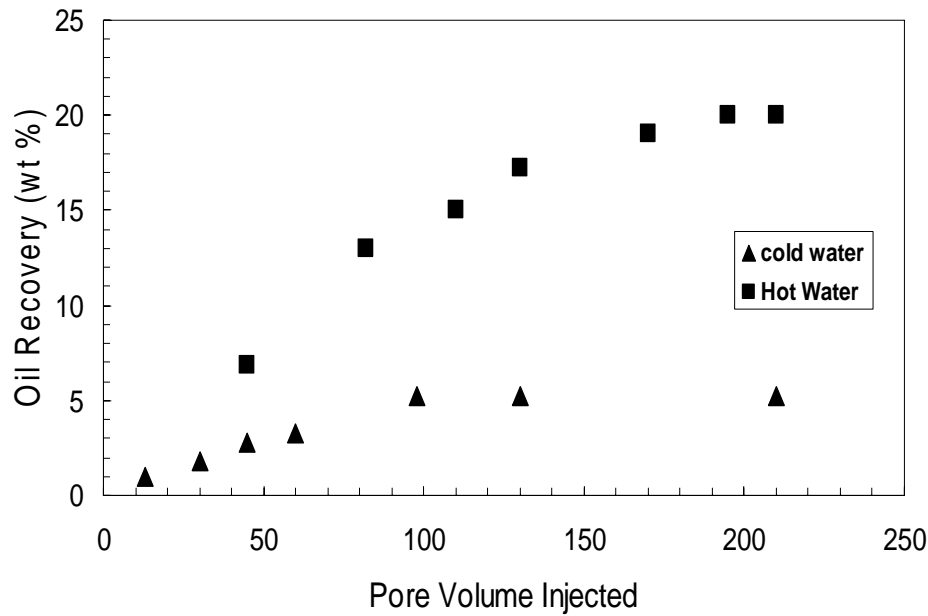

Fig. (8): % Oil recovery vs. PV for 0.2mm core size and heavy oil using cold and hot water.

Figure 5 shows oil recovery for different permeability (core sizes) and different oil types (35-API and 24-API). This figure shows that oil recovery for a 0.5 mm core size and light oil is larger than that of 0.2 mm and heavy oil. Figure 6 shows oil recovery for 0.5 mm core size and light oil with different steam types (saturated and superheated). Recovery, using superheated steam is higher than saturated steam by 2%.

Effect of Surfactant Addition

The addition of a surfactant reduces the segregation process and interfacial tension between oil and rock material. Figure 7 shows oil recovery for 0.2 mm core size and heavy oil, with saturated steam (at the saturated temperature), superheated steam (above saturation temperature) and superheated steam in the presence of a surfactant. A higher oil recovery was obtained when surfactants were added. This improvement in oil recovery can be explained by the mobility ratio (M_R) as defined in Equation 3. High sweep efficiency will be achieved due to the reduction in mobility ratio (M_R) of steam to oil. From Equation 3, we can see that this reduction can be

achieved either by decreasing the oil viscosity when it is heated by steam, or by increasing the surfactant viscosity when surfactants are added. When surfactant are added, this increases the viscosity of steam and in turn decreases the mobility of steam to oil in porous media. As a result, steam will have more sweep efficiency and reduce channeling.

$$\mu_R = \frac{M_s}{M_o} = \frac{K_s / \mu_s}{K_o / \mu_o} = \frac{K_s \mu_o}{K_o \mu_s} \tag{3}$$

Where: M_s, M_o : steam and oil mobility, respectively.

K_s, K_o : the effective permeability of steam and oil, respectively, where the effective permeability depends on the relative permeability (K_{ri}) and fluid saturation in porous media (S_i) as follows: $K_i = K_{ri} S_i$.

μ_s, μ_o : Viscosity of steam and oil, respectively.

Cold and Hot Water Injection

Cold water injection will result in oil displacement without decreasing its viscosity (secondary method). On the other hand, hot water decreases oil viscosity due to

heat transfer from water to core sample and oil. Therefore, it is expected that oil recovery is higher for hot water injection compared to cold-water injection. Figure 8 shows oil recovery for 0.2 mm core size and heavy oil using cold and hot water. Oil recovery by both methods is low. Maximum oil recovery was 5% for cold water and 20% for hot water. Recovery, based on water injection, was too low due a number of factors. Firstly, water does not fill all the pores of the core. Secondly, heat supplied to the cell by water is low. As a result, the reduction in oil viscosity is not high. Finally, steam distillation effect is not achieved when water is used. Steam drives differ markedly in performance from hot water drives, the difference in performance being due solely to the difference in the amount of heat and the effect of the condensing vapor. Steam has a higher amount of heat than hot water; latent and sensible heat is transferred from steam to the core sample, while sensible heat only transfers to the core when hot water is used. Additionally, the presence of the gas phase causes light components in the crude oil to be distilled and carried along the hydrocarbon components in the gas phase. When the steam condenses, the condensable hydrocarbon components do likewise, thus reducing the viscosity of the crude oil at the condensation front. Moreover, the condensing steam makes the displacement process more efficient and improves the sweep efficiency. As a result,

the net effect is that recovery from steam drives is significantly higher than from hot water drives.

CONCLUSIONS

Results obtained in this study lead to the following conclusions:

- a. Experimental data support the fact that injection of saturated steam will have a higher impact on oil removal in comparison to cold or hot water injection, due the fact that latent and sensible heat is transferred from steam to the core sample which results in the reduction of oil viscosity and causes light components in the crude to be distilled.
- b. Increase in permeability, API and cell temperature will increase oil recovery. Incremental oil recovery, when superheated steam is used, is low in comparison to saturated steam, which indicates that it is uneconomic to use superheated steam.
- c. Surfactant addition results in a slight improvement in oil recovery, due to the reduction in interfacial tension and its effect on the steam/oil viscosity ration which will in turn increase the oil mobility.

Acknowledgements

The authors would like to thank the Engineering Workshop at the Jordan University of Science and Technology for their invaluable contribution.

REFERENCES

- Allawzi, M.A. and Patton, J.T. 1994. Thermal Stability of Foam Additive in Steam Flood Core Tests. *SPE/DOE Improved Oil Recovery Symposium* 87-97, Tulsa, OK, USA, 87-97.
- Apaydin, O.G. and Kovscek, A.R. 2000. Transient Foam Flow in Homogeneous Porous Media: Surfactant Concentration and Capillary End Effects, *SPE/DOE Improved Oil Recovery Symposium*, Tulsa, OK, USA.
- Balshaw-Biddle, K., Oubre, C.L. and Ward, C.H. 2000. Steam and Electro-Heating for Remediation of Tight Soils, Lewis Publishers, Boca Raton, FL, USA.
- Davis, E. 1997. How Heat Can Enhance *in-situ* Soil and Aquifer Remediation: Important Chemical Properties and Guidance on Choosing the Appropriate Technique. Robert S. Kerr Environmental Research Laboratory, EPA/540/S-97/502.
- Davis, E. 1998. Steam Injection for Soil and Aquifer Remediation. Robert S. Kerr Environmental Research Laboratory. EPA/540/S-97/505.
- Dilgren, R. E. and Owens, K. B. 1982. Surfactant-enhanced Steam Drives for Heavy Oil Recovery, *JAOCS*, 59 (10), 818A-822A.

- Heron, G., Van Zutphen, M., Christensen, T.H. and Enfield, C.G. 1998. Soil Heating for Enhanced Remediation of Chlorinated Solvents. A Laboratory Study on Resistive Heating and Vapor Extraction in a Silty, Low-Permeable Soil Contaminated with Trichloroethylene, *Environ. Sci. Technol.*, 32 (10): 1474-1481.
- Heron, G., Carroll, S. and Nielsen, S. G. D. 2005. Full-Scale Removal of DNAPL Constituents Using Steam Enhanced Extraction and Electrical Resistance Heating, *Ground-Water Monit. Remediat.*, 25 (4): 92-107.
- Kovsck, A.R., Patzek, T.W. and Radke, C. J. 1997. Mechanistic Foam Flow Simulation in Heterogeneous and Multidimensional Porous Media, *SPE Journal*, 2 (4): 511-526.
- Schumacher, M. M. 1982. Heavy Oil and Tar Sands Recovery and Upgrading. *International Technology*, Noyes Data Corporation, NJ, USA.
- Siddiqui, S., Talabani, S., Saleh, S. T. and Islam, M. R. 2002. Foam Flow in Low-permeability Berea Sandstone Cores: A Laboratory Investigation, *J. Pet. Sci. Eng.*, 36 (3-4): 133-148.
- Smith, L.A. and Hinchey, R.E. 1993. *In Situ Thermal Technologies for Site Remediation*, Ft. Lewis Publishers, Boca Raton, FL, USA.
- Stewart, L.D. and Udell, K.S. 1988. Mechanisms of Residual Oil Displacement by Steam Injection, *SPE Reservoir Eng.* 3, 1233-1242.
- Stewart, L. D. and Udell, K. S. 1989. The Effects of Gravity and Multiphase Flow on the Stability of Steam Condensation Fronts in Porous Media, *Multiphase Transport in Porous Media*, ASME HTD.
- Udell, K.S. and Stewart, L.D. 1989. UCB-SEEHRL. 89-2. In: University of California, Berkeley, CA, USA.
- U.S. Environmental Protection Agency. 2004. *In Situ Thermal Treatment of Chlorinated Solvents-Fundamentals and Field Applications*, EPA542-R-04-010 57.
- Willman, B. T., Valleroy, V. V., Runberg, G. W., Cornelius, A. J. and Powers, L. W. 1961. Laboratory Studies of Oil Recovery by Steam Injection, *J. Pet.Tech.* 7: 681-690.