

## Non-linear Analysis of High Strength Reinforced Concrete Beams with Large Openings

*Qasim M. Shakir*

Department of Civil Engineering, College of Engineering, University of Kufa, Iraq.  
E-Mail: Qasimmsalabbas.uokufa.edu.iq

### ABSTRACT

In the present work, a non-linear finite element (FEM) analysis has been conducted in order to investigate the performance of high strength R.C. beams including large openings. Seven beams have been considered with different opening sizes (max. size of 120\*480). Further, a beam of (120\*600) mm opening has been studied to investigate the behavior of beams with larger openings.

To improve the performance of beams with large openings, two of the most commonly used methods in strengthening have been adopted. These are: increasing top and bottom steel ratios and jacketing of openings with steel plates.

The analysis results showed that when the opening size was increased, the ultimate load capacity decreased gradually following a path very close to parabolic and that adopting high top and bottom steel ratios (about 8%) improved the ultimate load capacity by 59%. Also, it was found that strengthening the opening by a steel jacket of 3mm thickness improved the response of beams by 10% and 29% for cases of partial and full jacketing, respectively, while for a jacket of 5mm thickness, the capacity was improved by 22% and 44% for the two methods of jacketing.

**KEYWORDS:** Non-linear analysis, R.C. beams, High strength, Large openings, Cracking, Strengthening, Jacketing.

### INTRODUCTION

In practical life, it is quite often to use several networks of pipelines to accommodate some services, such as ventilating ducts, heating pipes, sewerage pipes and power cables (Yang and Ashour, 2007; Saeed and Yousif, 2013). Usually, these pipes and ducts are placed underneath floors, then are covered by a suspended ceiling. This leads to create a dead load and increase the building height. This results in an added dead load and a reduction in lateral stability. Thus,

incorporating openings in floor beams will reduce such problems (Mansur, 2006).

Sudden changes in the dimensions of cross-section of the beam may result in a stress concentration at the corners of the opening and reduction of stiffness, leading to deformation and excessive deflection under service load as well as to considerable redistribution of forces and internal moments in continuous beams. Thus, the design of such beams needs special consideration (Saksena and Patel, 2013).

An opening may be small or large. Most of previous works considered small openings (Mansur, 2006; Saksena and Patel, 2013; Daniel and Revathy, 2014; Rashwan et al., 2014). But sometimes, such

---

Received on 11/3/2015.

Accepted for Publication on 6/5/2015.

openings may not satisfy the utility requirements. Therefore, it is necessary to adopt larger openings (Mansur, 2006; Sahoo, 2012). Some of the parameters that affect the performance of beams with large openings are: size of the opening, span of the beam and reinforcement details of the beam.

In the present work, a finite element analysis has been conducted using ANSYS-V.14 for some beams with openings tested experimentally by Abdul Hafez (2009). A comparison of results has been made to calibrate to material models adopted in this study. Two methods to improve the performance of beams with large openings have been discussed.

**MATERIAL PROPERTIES**

**Concrete**

Compressive uni-axial stress-strain behavior has been simulated by an elasto-plastic work hardening model followed by perfectly plastic response terminated at the onset of crushing. Such behavior, as shown in Fig. (1), can be represented using the following equations (Anthony, 2004):

$$f_c = \varepsilon E_c \text{ for } 0 \leq \varepsilon \leq \varepsilon_1 \tag{1}$$

$$f_c = \frac{\varepsilon E_c}{1 + (\varepsilon/\varepsilon_0)^2} \text{ for } \varepsilon_1 \leq \varepsilon \leq \varepsilon_0 \tag{2}$$

$$f_c = f'_c \text{ for } \varepsilon_0 \leq \varepsilon \leq \varepsilon_{cu} \tag{3}$$

and

$$\varepsilon_1 = 0.3f'_c / (E_c) \text{ (Hooke's law)} \tag{4}$$

$$\varepsilon_0 = 2f'_c / (E_c)$$

$$E_c = 3.3\sqrt{f'_c} + 6.9 \text{ (Kumar et al., 2012).} \tag{5}$$

Fig. (2) shows the stress stiffening model adopted to represent concrete in tension. The initial modulus of elasticity is used up to the first crack. Then, a smeared crack model is adopted to consider propagation of cracks.

**Steel Reinforcing Bars**

Stress-strain behavior adopted in the present work in order to simulate reinforcing steel bars is assumed to be elastic up to the steel yield stress ( $f_y$ ), followed by linear hardening up to the steel ultimate strength ( $f_u$ ) as shown in Fig. (3).

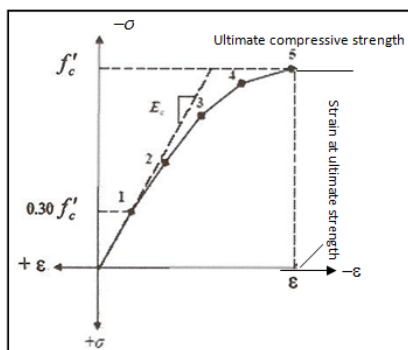

**Figure (1): Uniaxial stress-strain curve for concrete**

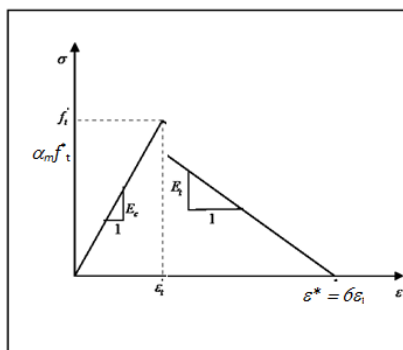

**Figure (2): Tension stiffening model**

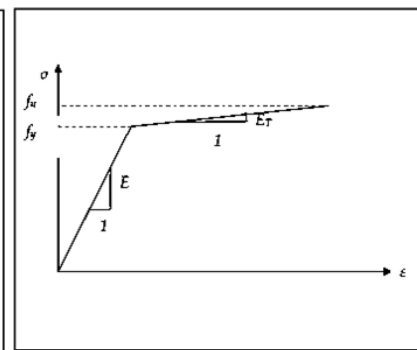

**Figure (3): Uniaxial stress-strain relation for steel**

**Geomerty of Tested Beams**

Seven beams with overall dimensions of (2000mm\*300mm\*120mm) with different opening sizes have been studied in the present work. These

beams have been experimentally tested by Abdul Hafez (2009). The span between supports is (1800 mm). The details of dimensions and openings of the beams are shown in Fig. (4) and Table (1). Compressive strength

values of concrete and yield strength values of steel are listed in Tables (1) and (2), respectively.

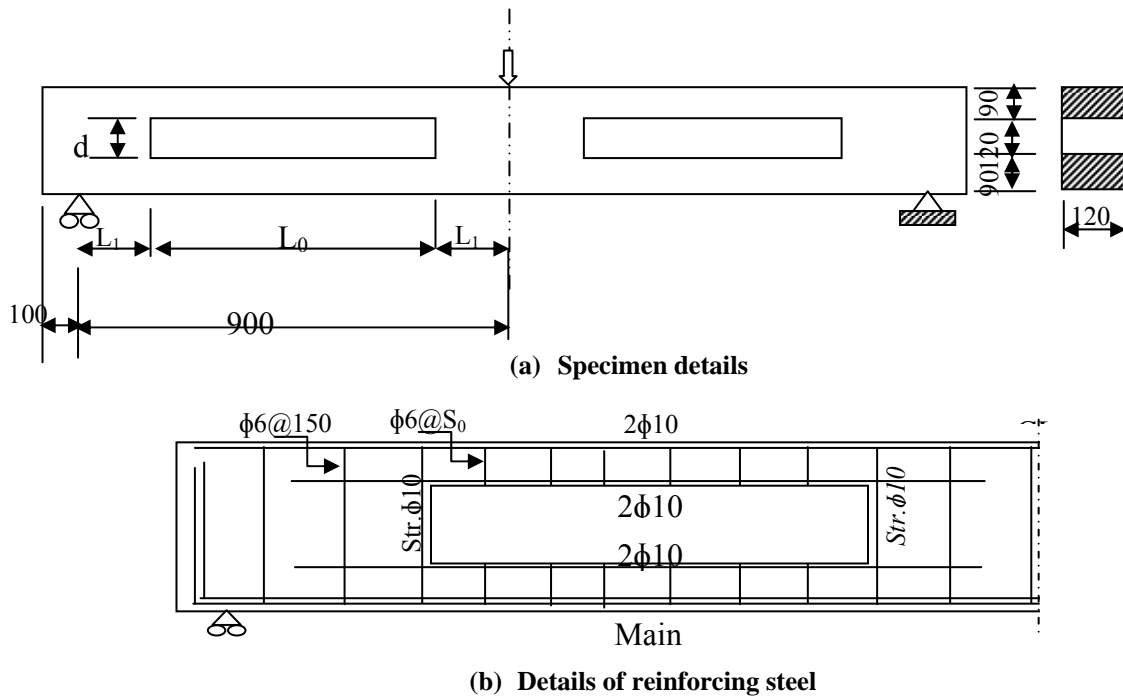

Figure (4): Specimen and reinforcing steel details (Abdul Hafez, 2009)

Table 1. Properties of tested beams (Abdul Hafez, 2009)

Beam No.	$L_0$	$L_1$	$F'_c$	Main reinf.	$S_0$ for str.
BS-1	-----	-----	57.12	4φ12	-----
BS-2	240	330	56.17		50
BS-3	360	270	56.36		50
BS-4	480	210	61.71		50
BS-7	-----	-----	61.90	4φ16	-----
BS-8	360	270	60.94		50
BS-9	360	270	60.94		100

Table 2. Test results of reinforcing steel (Abdul Hafez, 2009)

Bar Dia.(mm)	6	10	12	16
$f_y$ (MPa)	330	490	520	550

**Finite Element Modeling**

Due to symmetry, a quarter of full beam was considered as shown in Fig. (5). Shown are also

boundary condition and loading condition supports.

The elements adopted in the present study were:

- Solid element, solid 65 used to simulate concrete.

- Solid element, solid 185 used to simulate loading and supporting plates.
- 3-dim spar element, link180 used to represent all types of steel bars.

Each node of the adopted elements has three degrees of freedom (x, y and z translations). Perfect bond between steel and concrete elements was assumed.

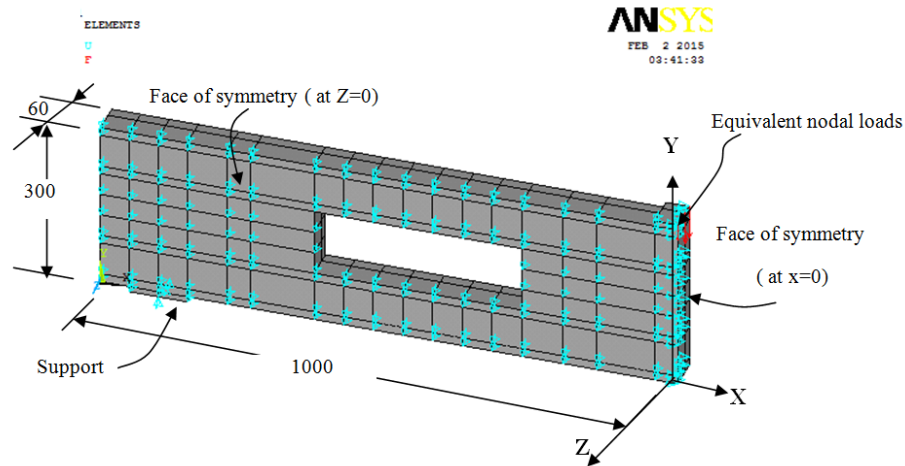

**Figure (5): Finite element model adopted in the present work**

### Load-Deflection Results

The load mid-span deflection curves for the tested beams are shown in Figs. (6) to (12). It can be seen that the results of numerical analysis for most of the beams including openings seem to be stiffer than experimental ones in the early stages of loading. Then, the theoretical results tend to be closer to those obtained experimentally. This may be attributed to the assumption of full bond between concrete and steel adopted in this study. This bond diminishes with the progress of loading and spreading of cracks around steel resulting from slippage of steel bars.

Figs. (11) and (12) show the load deflection curves for beams BS8 and BS9. It can be seen that upon increasing spacing of links within the chords of the opening from 50 mm to 100 mm, the load capacity reduced by 16% and 14% for present theoretical and experimental studies (Abdul Hafez, 2009).

The same beam BS4 is studied, but with an opening of 600mm (24% of the total area) to investigate beams

with larger openings and to yield the case adopted in the parametric study. Fig. (13) shows the effect of opening width on ultimate load capacity. It can be seen that the results of finite element analysis are very close to those of experimental tests with difference rates between 1% and 4%.

### Crack Patterns

In this section, the crack patterns for the tested beams are shown and discussed. For comparison, a load level of (90 kN) has been chosen. This is, nearly, the load capacity for beam BS4, which is the weakest one among all the tested beams. Crack initiation and propagation across the beam have been monitored.

Figs. (14) to (21) show the manner of crack development at a load level of about 90 kN. It can be obviously seen that cracks are concentrated around and close to the corners of openings, which is attributed to concentration of stresses at these points.

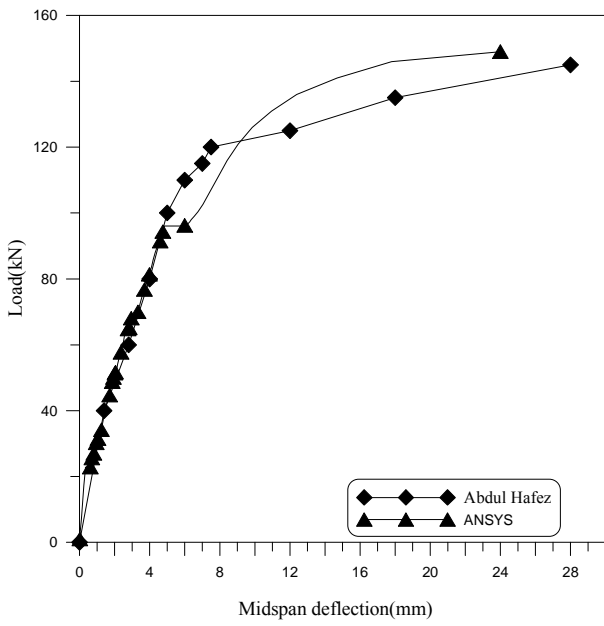

Figure (6): Load-deflection curve for beam BS1

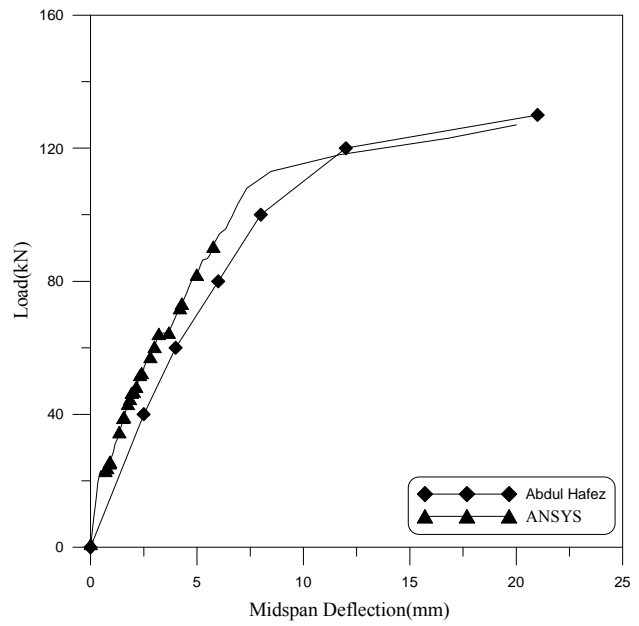

Figure (7): Load-deflection curve for beam BS2

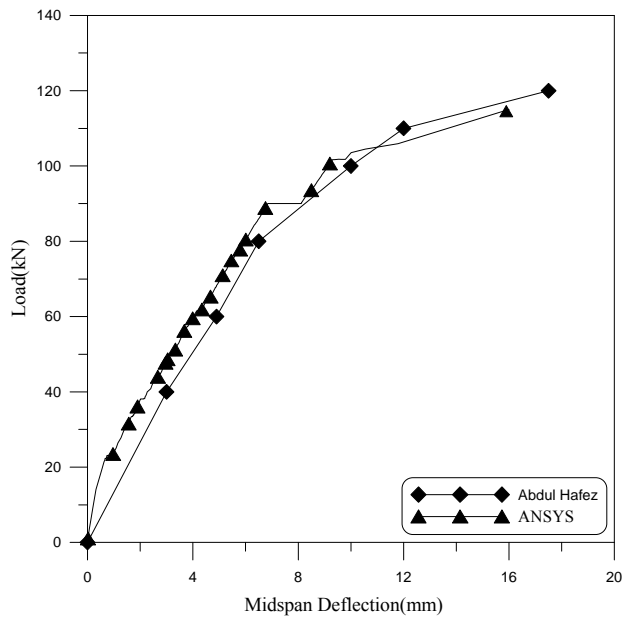

Figure (8): Load-deflection curve for beam BS3

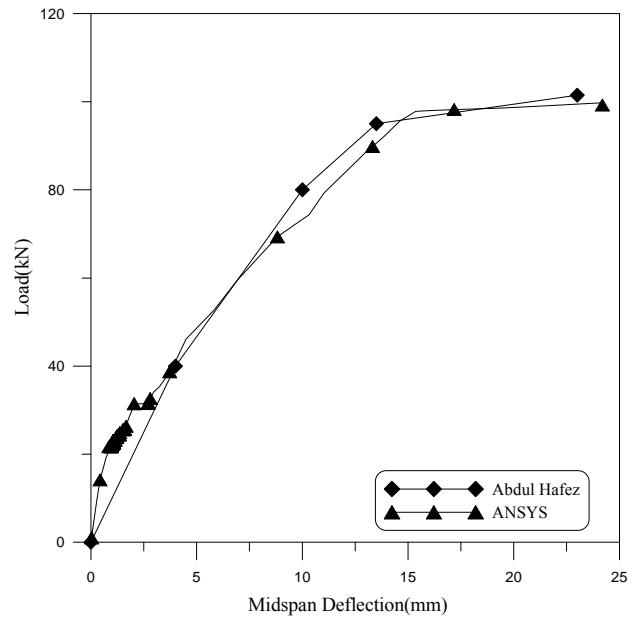
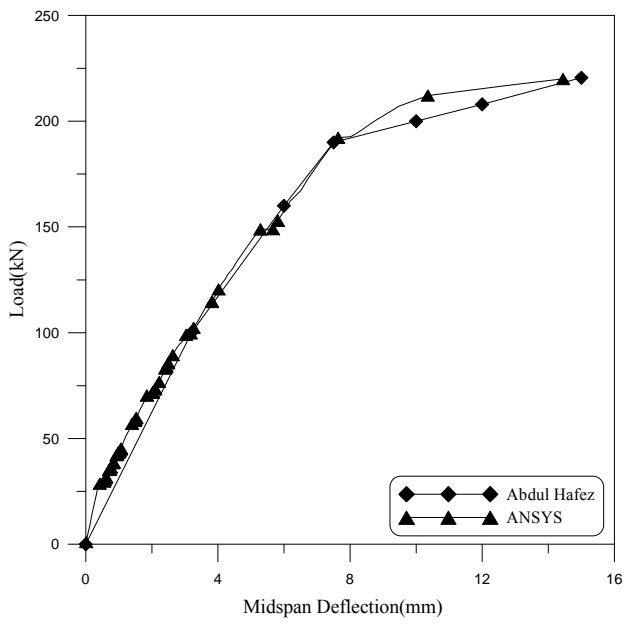

Figure (9): Load-deflection curve for beam BS4

Fig. (14) shows the crack pattern of beam BS1. It can be seen that most of the cracks have developed at the zone of maximum moments with some cracks

spreading towards the supports. This leads to the expectation that failure is of flexural type with some diagonal cracks occurring at the final stages of loading.



**Figure (10): Load-deflection curve for beam BS7**

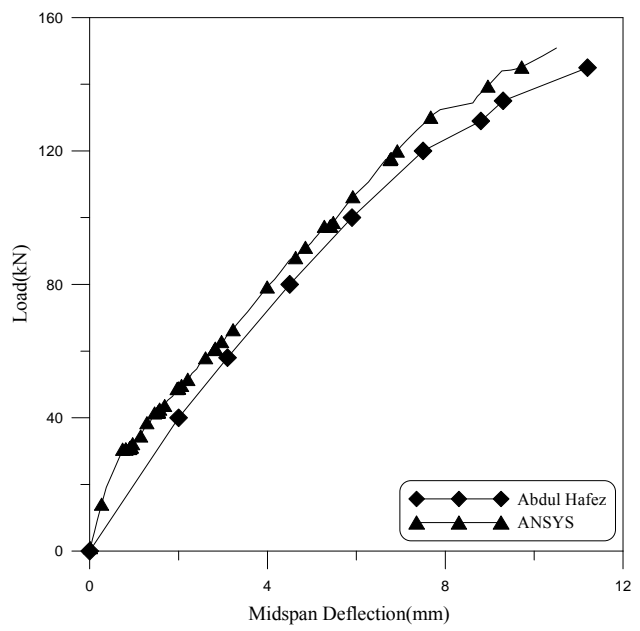

**Figure (11): Load-deflection curve for beam BS8**

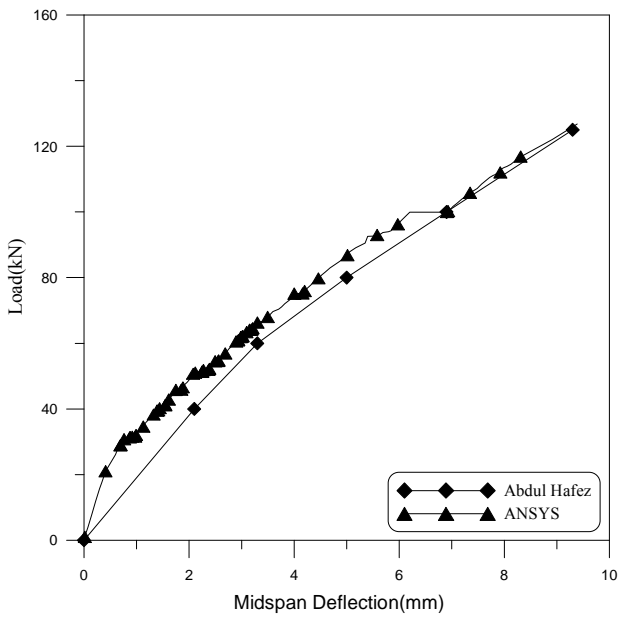

**Figure (12): Load-deflection curve for beam BS9**

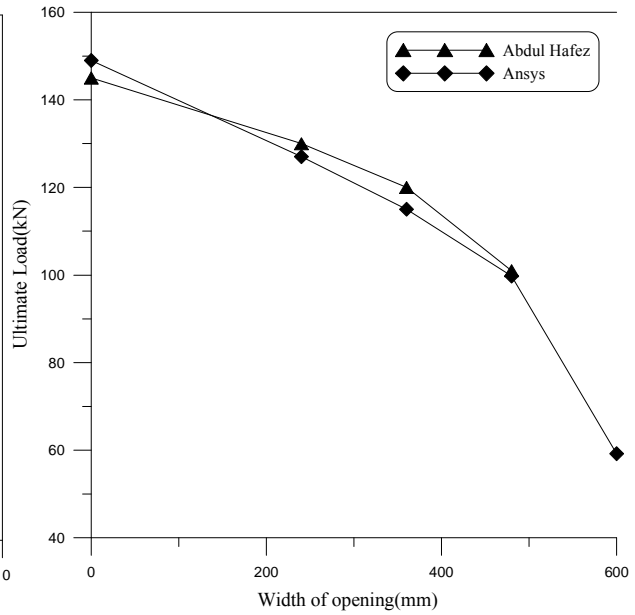

**Figure (13): Effect of opening width on ultimate load capacity**

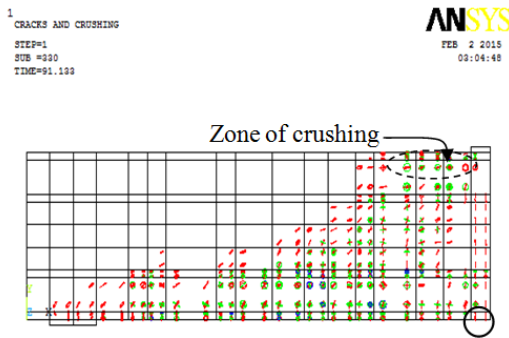

**Figure (14): Crack pattern at a load of 90 kN for beam BS1**

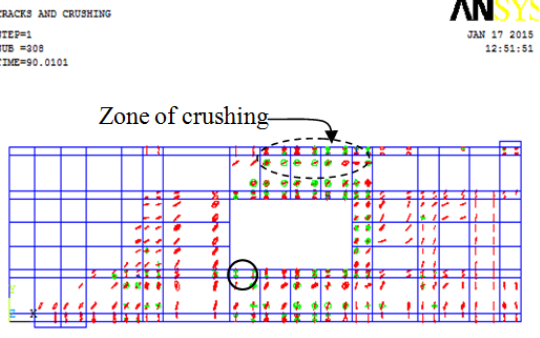

**Figure (15): Crack pattern at a load of 90 kN for beam BS2**

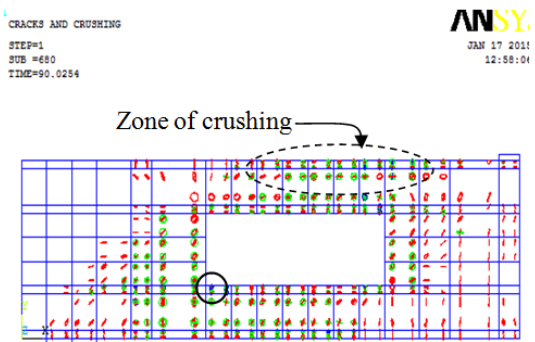

**Figure (16) Crack pattern at a load of 90 kN for beam BS3**

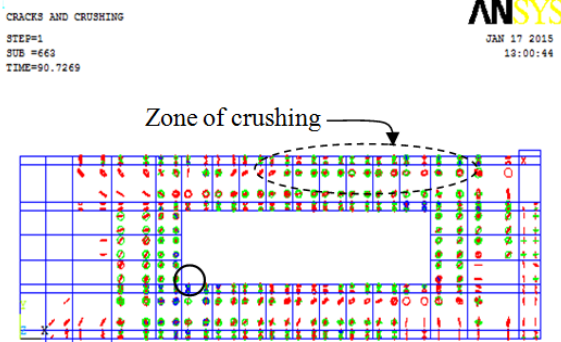

**Figure (17): Crack pattern at a load of 90 kN for beam BS4**

Also, it can be simply realized that introducing openings in beams results in capacity reduction. Capacity diminishes with larger openings. The manner of triple crack spreading shows that failure will occur at the opening zone as shear type at the bottom chord and as some spalling of concrete at the top chord. This zone of spalling, which is indicated by dashed figures, increases gradually with increasing the size of the opening.

Results also indicated that the first crack in the solid beams occurred at mid-span, whereas for all beams with openings the first crack initiated at the left bottom corner. The position of the first crack initiation is indicated by small solid circles.

Fig.(18) shows the crack pattern for beam BS7. It can be seen that no crushing occurred at this load level. Distribution and direction of cracks give an impression

that the failure mode may be similar to that in beam BS1. First crack initiated at the same point as beam BS1, but with higher load level.

Fig. (19) shows the crack pattern for beam BS8. A comparison with Fig. (16) shows that the effect of the bottom steel ratio seems to be obvious, then one can realize that the number and type of cracks are clearly related by this aspect.

Fig. (20) shows the crack pattern for beam BS9. This test aimed at investigating the effect of spacing of links in the chords of the opening on the response. A comparison of Fig. (20) with Fig. (19) shows that there is a small effect of link spacing on the rate of crack propagation at a load level of 90 kN. This effect develops close to the final stages of loading and is clear in load deflection curves for beams BS8 and BS9 as shown in Fig. (11) and Fig. (12), respectively.

**Parametric Study**

Two of the most commonly used methods to improve the response of beams including large voids have been discussed in the parametric study. The first method can be used before concrete casting and

considered in the stage of design of the beam. It is the variation of the top and bottom steel ratios. The second one is a strengthening technique that can be adopted beyond concrete hardening. It is a form of steel jacket for the opening.

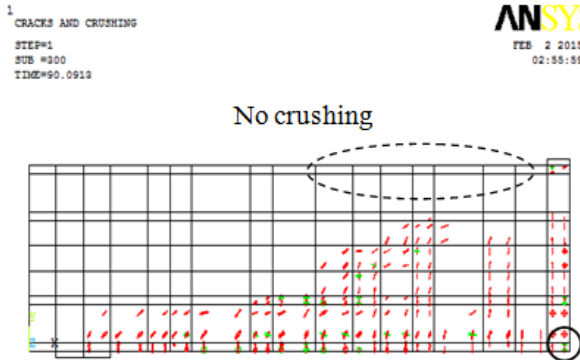

**Figure (18): Crack pattern at a load of 90 kN for beam BS7**

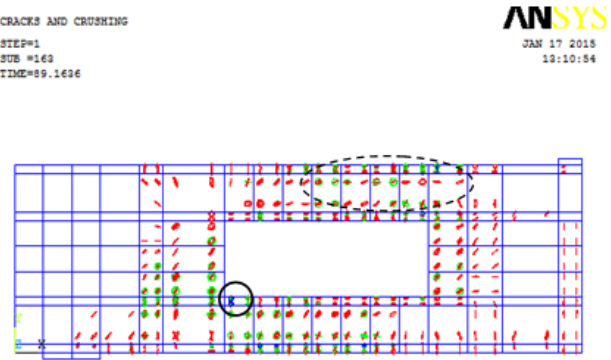

**Figure (19): Crack pattern at a load of 90 kN for beam BS8**

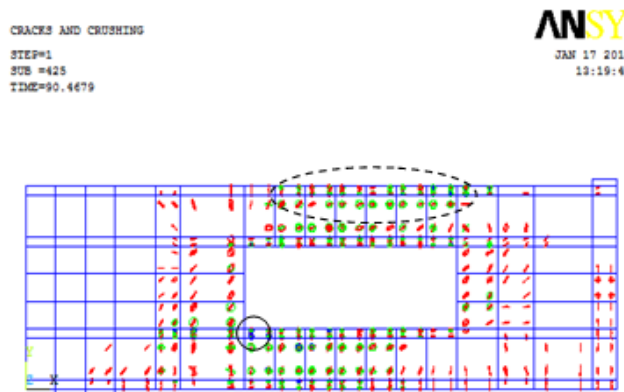

**Figure (20): Crack pattern at a load of 90 kN for beam BS9**

**Effect of Steel Ratio**

The top steel ratios in the top and bottom of the beam with an opening size of (600\*120) and the same material properties as for beam BS4 have been changed in several patterns. Then, the ultimate capacity has been determined. Steel at the top, around and under the opening is identified as layer1 to layer 4 as shown in

Fig. (21). The details of all configurations are listed in Table (3). The results are shown in Fig. (22). It can be seen that the best result for ultimate capacity is yielded with the tensile steel ratio of about 8% (max. steel ratio allowed by ACI code), while the compression steel ratio is slightly less than 8%.



Table 3. Different configurations of the long. steel in the beam

Section	Top reinf.		Ratio	Bot. reinf.		Ratio	Pu
	Layer 1	Layer 2		Layer 3	Layer 4		
B6-0	2 $\phi$ 10	2 $\phi$ 10	0.029089	2 $\phi$ 10	4 $\phi$ 12	0.05643	59.20
B6-1	2 $\phi$ 12	2 $\phi$ 10	0.035448	2 $\phi$ 10	4 $\phi$ 12	0.05643	62.22
B6-2	2 $\phi$ 16	2 $\phi$ 10	0.051778	2 $\phi$ 10	4 $\phi$ 12	0.05643	66.05
B6-3	2 $\phi$ 16	2 $\phi$ 10	0.051778	2 $\phi$ 12	4 $\phi$ 12	0.06283	67.20
B6-4	4 $\phi$ 12	2 $\phi$ 10	0.056432	2 $\phi$ 12	4 $\phi$ 12	0.06283	72.71
B6-5	4 $\phi$ 12	2 $\phi$ 10	0.056432	2 $\phi$ 10	4 $\phi$ 16	0.08901	87.00
B6-6	3 $\phi$ 16	2 $\phi$ 10	0.070395	2 $\phi$ 10	4 $\phi$ 16	0.08901	94.08
B6-7	4 $\phi$ 16	2 $\phi$ 10	0.089012	2 $\phi$ 10	4 $\phi$ 16	0.08901	89.16

**Effect of Steel Jacketing**

One way to overcome the reduction in beam capacity due to wide opening is strengthening the interior faces of the opening with 3mm and 5mm steel plates with a yield stress of 350 MPa. For each

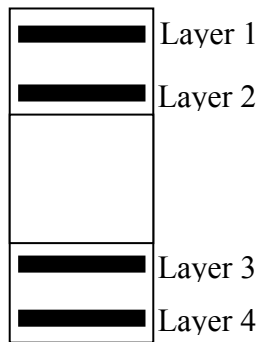
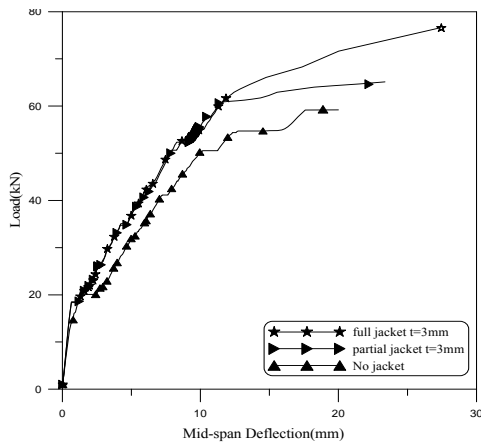

Figure (21): Layers of steel reinforcement



(a) plate thickness t=3mm

thickness, two cases of jacketing have been used. In the first, all the faces but the mid 100mm top and bottom faces have been jacketed. In the other, full jacketing has been adopted. The results are compared with those for beams without jacketing.

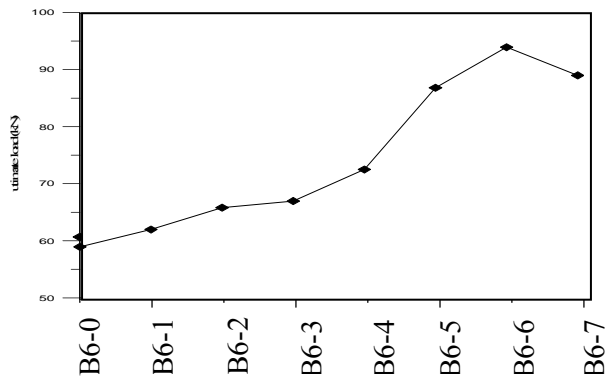
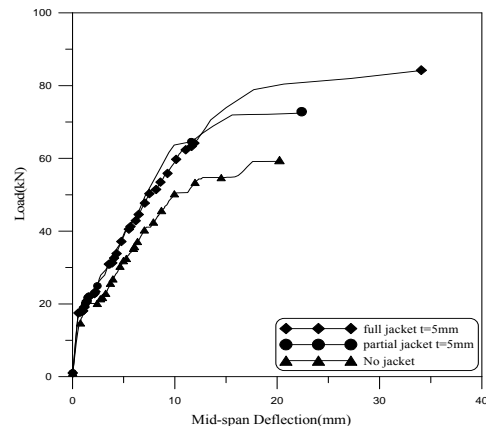

Figure (22): Effect of longitudinal steel configuration on ultimate load



(a) plate thickness t=5mm

Figure (23): Effect of steel jacketing on load capacity

It can be seen from Fig. (23) that using a steel plate of a thickness of 3mm with partial and full jacketing improved the capacity by about 10% and 29%, respectively. In the case of the plate of 5mm thickness, the capacity has been improved by about 22% and 44% for partial and full jacketing, respectively. Also, for a steel plate with a thickness of 5mm, the maximum deflection is increased by 15% when partial jacketing is adopted and by 75% for full jacketing. This proves that ductility is improved with using the steel jacket. However, a steel plate with 3mm thickness has less effect on ductility than a steel plate with 5mm thickness.

### CONCLUSIONS

Based on finite element analysis conducted in the present study, the following conclusions can be drawn:

1-Incorporating openings within reinforced concrete beams results in reduction in ultimate load capacity. For beams with top and bottom steel ratios of (3%) and (5.6%), increasing the opening width from (240 mm) to (600 mm) results in a reduction in load capacity by about (53%).

2-The ratio of tensile steel has a significant effect on the performance of R.C. beams with openings. It is

found that increasing the bottom ratio from (5.6%) to (8%) and the top ratio from (3%) to (7%) leads to an increment in load capacity of (59%).

3-The maximum volume of the opening /total volume of the beam that can be adopted with acceptable performance is found to be (24%) instead of (19%) experimentally adopted, but with one of the methods discussed in the present work.

4-Beam load capacity and ductility can be improved by strengthening the interior faces of the opening by a steel jacket of suitable thickness. In the present work, using partial and full strengthening of the opening improved the ultimate load capacity by 10% and 29% for a steel plate with 3mm thickness and by 22% and 44% for a steel plate with 5mm thickness.

5-It is found that using a full jacket for the opening results in considerable improvement in ultimate load capacity; i.e., adopting a steel plate of 3mm thickness results in a load capacity of (76kN), which is better than the case with using steel ratios of 5.6% and 6.2% at the top and bottom faces of the beam (72kN). Also, for a plate with a thickness of 3mm the capacity is found very close to that developed by using steel ratios at the top and bottom faces of the beam of 5.6% and 8.9%. This results in some savings in steel used in reinforcing beams containing large openings.

### Notation

$f_c$  : stress at any strain  $\varepsilon$ , (MPa)

$\varepsilon$  : strain at stress  $f$

$\varepsilon_o$ : strain at ultimate compressive strength stress  $f^c$

$E$ : concrete elastic modulus, taken as (MPa)

$\alpha_m$ : tension stiffening factor

$f_t$ : tensile strength of concrete

$f_y$ : steel yield stress

$f_u$ : steel ultimate strength

FEA: finite element analysis

R.C.: reinforced concrete.

## REFERENCES

- Abdul Hafez, A.M. (2009). "Behavior of high strength concrete beams with opening subjected to static and repeated loadings". *Journal of Eng. Sciences, Assiut University*, 37 (6), 1343-1358.
- Anthony, J., and Wolanski, B.S. (2004). "Flexural behavior of reinforced and prestressed concrete beams using finite element analysis". M.Sc. Thesis, 57.
- Daniel, J.J., and Revathy, J. (2014). "Experimental investigation on flexural strength of beams with openings". *International Journal of Research in Management and Technology*, 4 (2).
- Hafiz, R.B., Shaibal Ahmed, S., Barua, S., and Chowdhury, R.S. "Effects of opening on the behavior of reinforced concrete beam". (*IOSR-JMCE*), 11 (2), 52-61.
- Kumar, M., Ma, Z., and Moses Matovu, M. (2012). "Report on the mechanical properties of high-strength concrete". University at Buffalo, State University of New York.
- Mansur, M.A. (2006). "Design of reinforced concrete beams with web openings". *Proceedings of the 6<sup>th</sup> Asia-Pacific Structural Engineering and Construction Conf.*, September 2006, Kuala Lumpur, Malaysia.
- Rashwan, M.M., Elsayed, A.A., Abdallah, A.M., and Hassanean, M.A.M. (2014). "Behavior of high-performance continuous R.C. deep beams with openings and their strengthening". *Journal of Engineering Sciences, Assiut University*, 42 (5), 1138-1162.
- Saeed, J.S., and Yousif, A.R. (2013). "Tests of fibrous and non-fibrous reinforced concrete continuous deep beams with web openings". *Journal of Zankoy Sulaimani, Part A (JZS-A)*.
- Sahoo, D.R., Flores, C.A., and Chao, S. (2012). "Behavior of steel fiber-reinforced concrete deep beams with large openings". *ACI Structural Journal*, 109 (2), 193-204.
- Saksena, N.H., and Patel, P. (2013). "Experimental study of reinforced concrete beam with web openings". *International Journal of Advanced Engineering Research and Studies-India*, 2 (3).
- SAS ANSYS 14.0. (2005). "Finite element system". SAS IP, Inc., USA.
- Yang, K.H., and Ashour, A.F. (2007). "Structural behaviour of reinforced-concrete continuous deep beams with web openings". *Magazine of Concrete Research*, 10, 699-711.